

hidrobox[®]
by absara

PLATOS DE DUCHA
Y PANELES

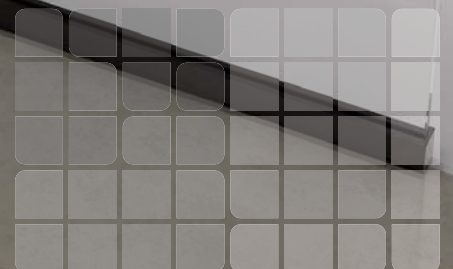

hidrobox[®]

**PLATOS DE DUCHA
Y PANELES**

ES.V.05.18

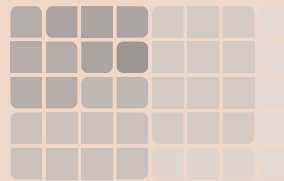

hidrobox®

PLATOS DE DUCHA Y PANELES

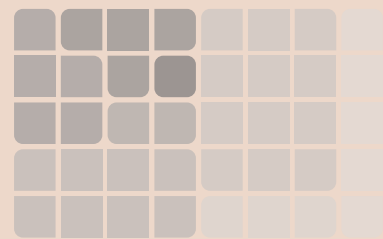

Catálogo de platos de ducha y Paneles
Tarifados
Información técnica
ver índice



Paneles
pág. 138

Repuestos y Complementos
pág. 146

Materiales
pág. 150



Unique

8



Select

34



Studio Plus

46



Zone

54



Line & Moon

62



Cube & Quadro

80



Nature & Neo

92



One

108



Arq

120



Visual

132



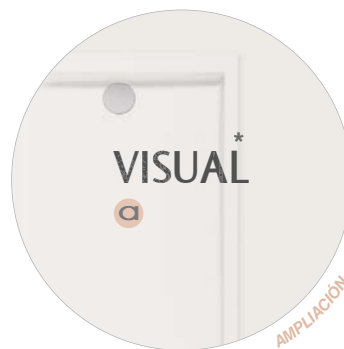
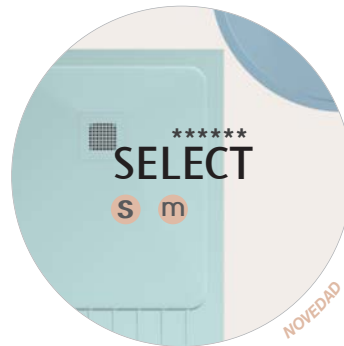

CUSTOM LEVEL

Scene
s

marmek
m

gelcoat
g

acrylic
a

GUIA RAPIDA

UNIQUE **S** **m**



* Hasta 400 cm de largo mediante el ensamblaje de dos unidades coordinadas

SELECT **S** **m**

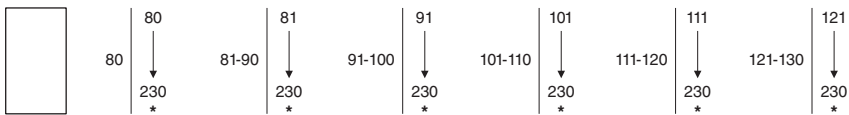

* Hasta 400 cm de largo mediante el ensamblaje de dos unidades coordinadas

STUDIO PLUS **S**

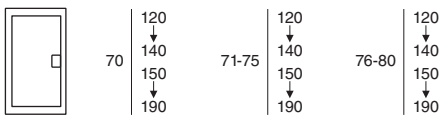

ZONE **S**

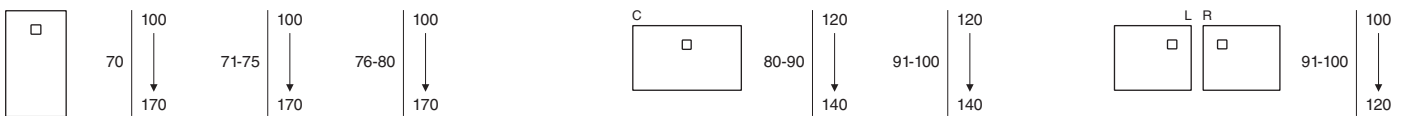

LINE & MOON **S** **m**

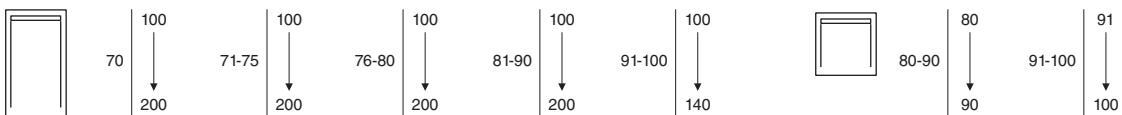

Line & Moon X

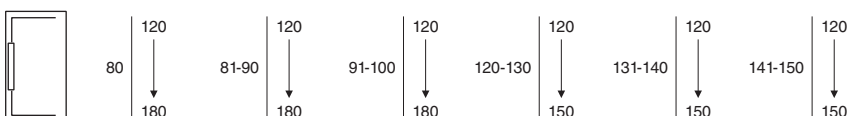

Line & Moon Y

DE FORMATOS

PLATOS DE DUCHA

CUBE & QUADRO **S m**

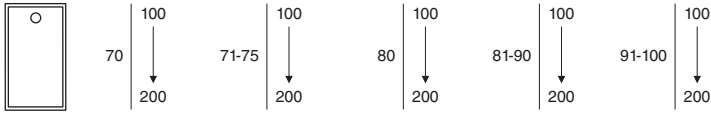

NATURE & NEO **S m**

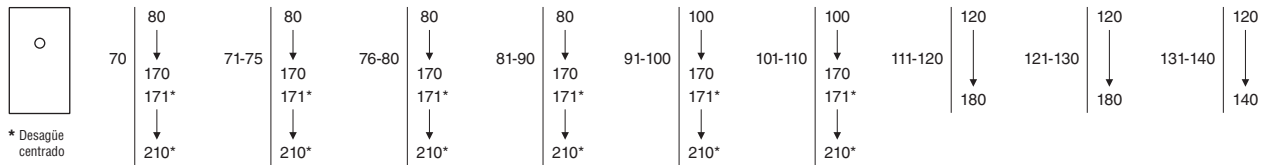

* Desagüe centrado

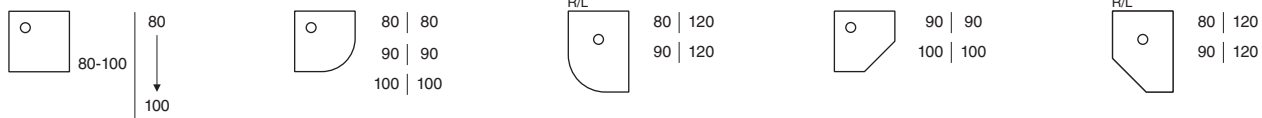

ONE **g**

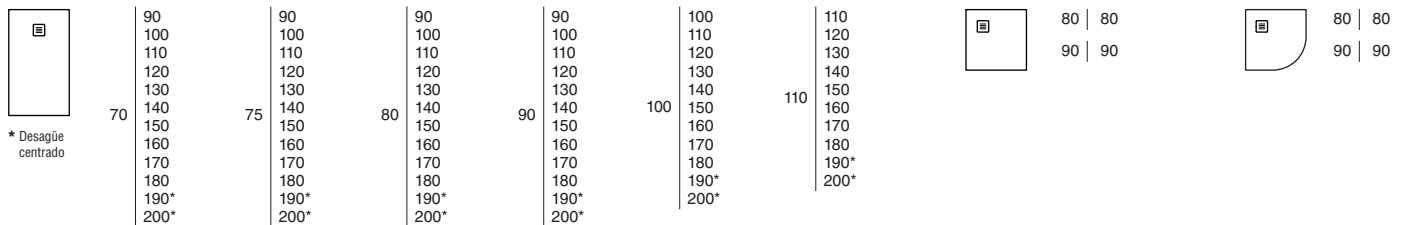

* Desagüe centrado

ARQ **g**

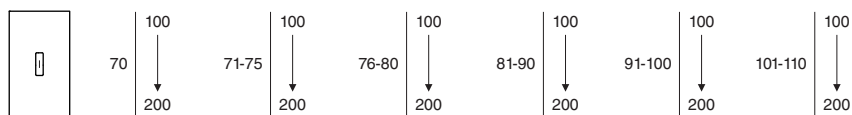

VISUAL **a**

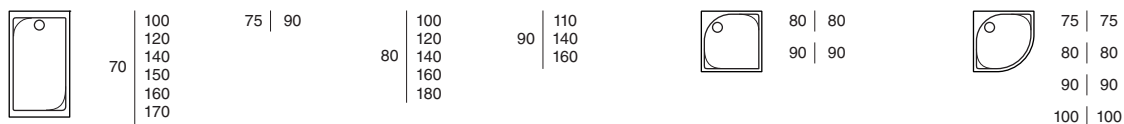

Scene

marmek

gelcoat

acrylic

S

m

g

a

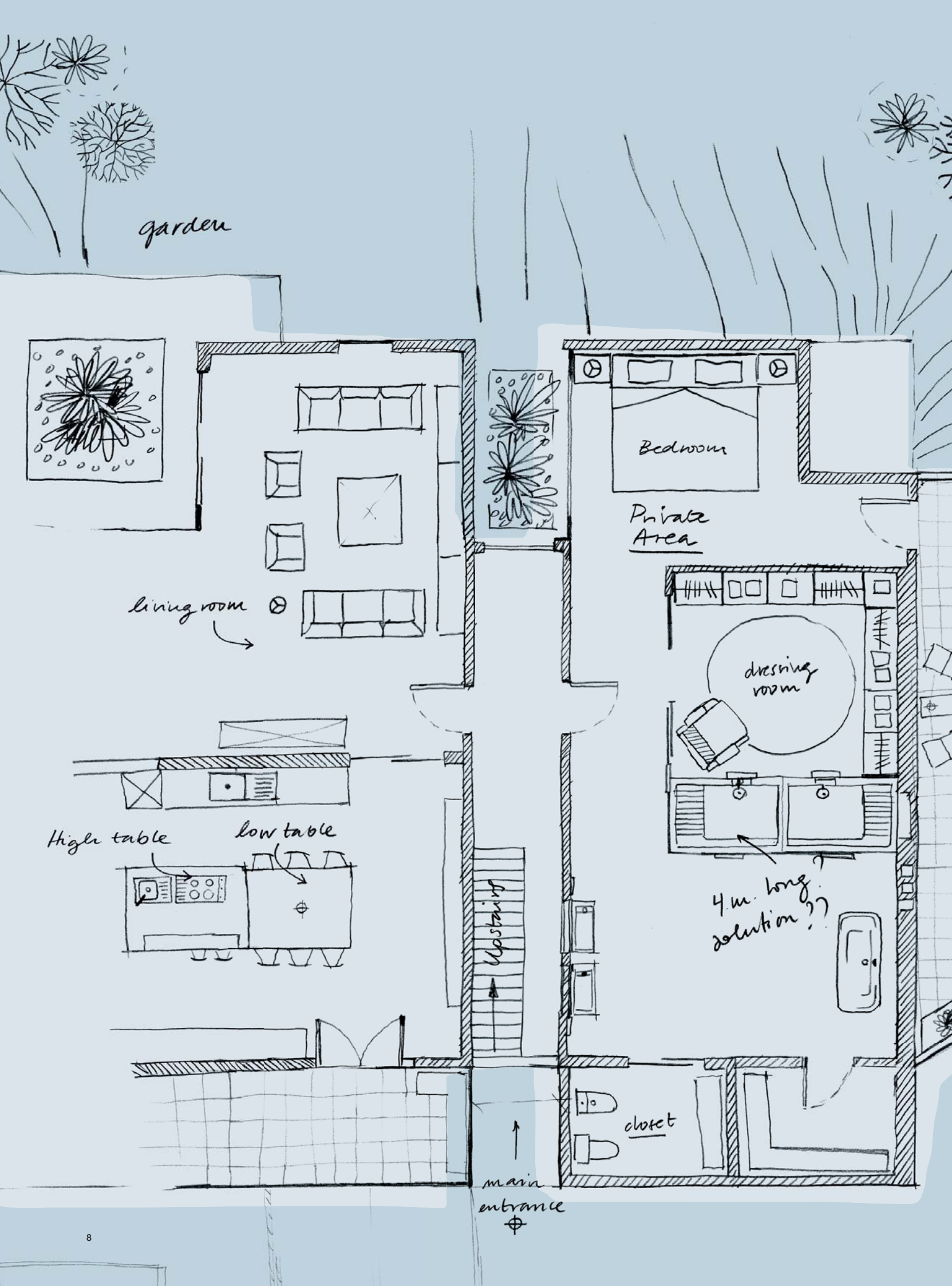

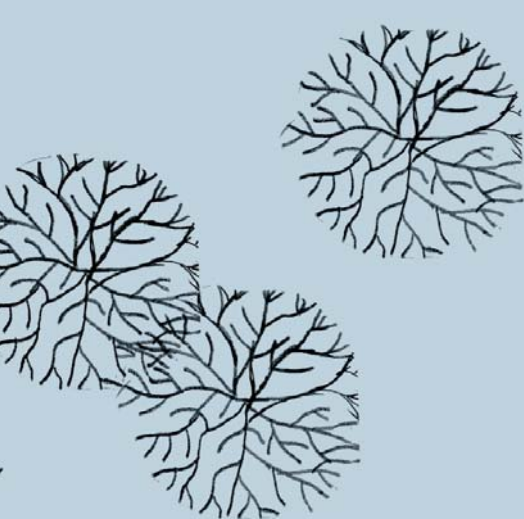

*garden
area (2)*



solarium

UNIQUE

Pensado para apoyar a los creadores de soluciones singulares en espacios de ducha,
ofreciendo nuevas posibilidades en el mundo del diseño



Private Area

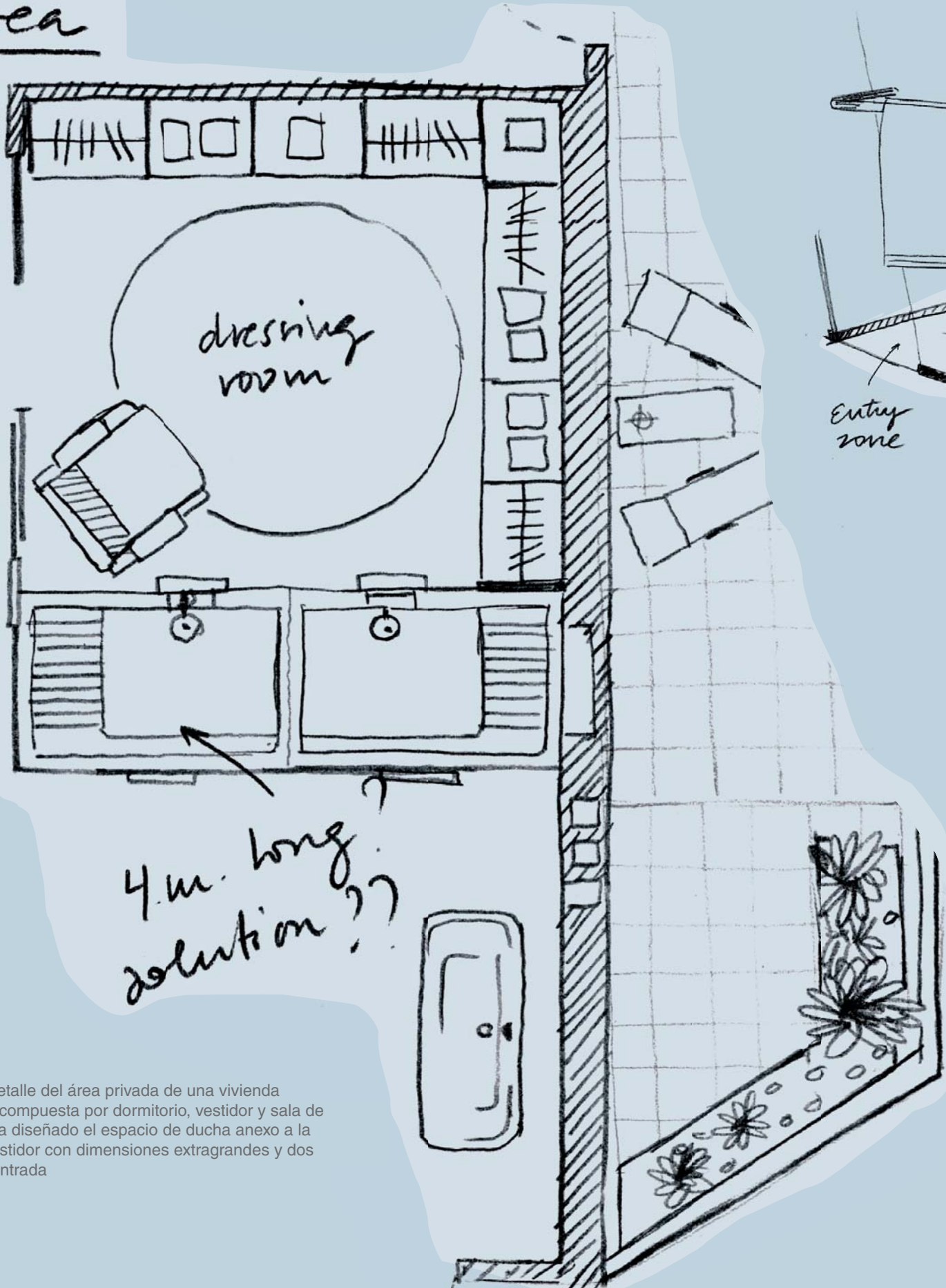

4 m. long
solution??

Ejemplo: detalle del área privada de una vivienda unifamiliar compuesta por dormitorio, vestidor y sala de baño. Se ha diseñado el espacio de ducha anexo a la zona de vestidor con dimensiones extragrandes y dos zonas de entrada

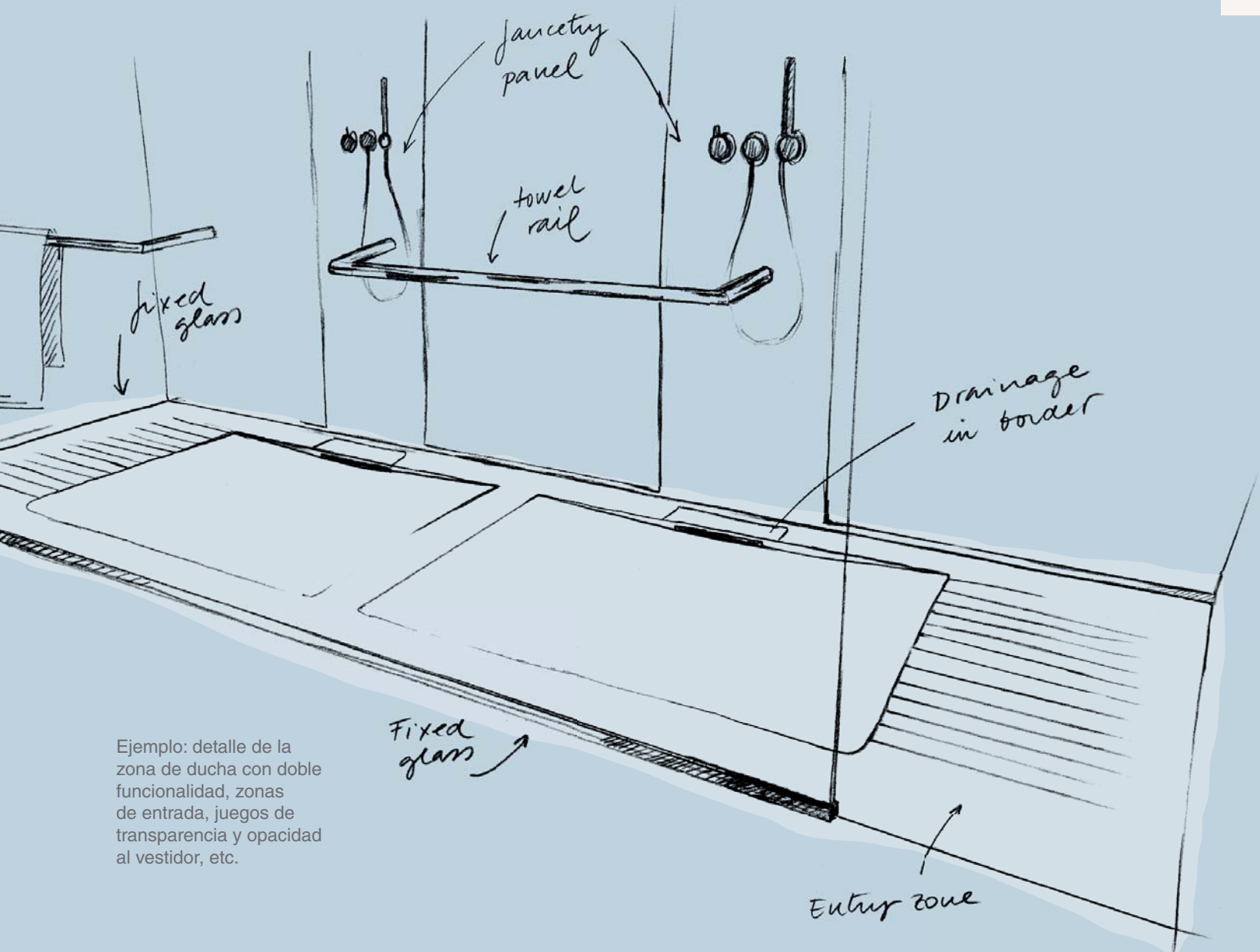

Ejemplo: detalle de la zona de ducha con doble funcionalidad, zonas de entrada, juegos de transparencia y opacidad al vestidor, etc.

La serie Unique está desarrollada para ofrecer soluciones de nivel individualizado a cada espacio de ducha.

Encontramos la libertad de definir la forma para un espacio determinado además de poder recurrir a diferentes tipologías y posiciones de desaguado. Este concepto permite reunir el mejor resultado en estética y funcionalidad para ofrecerle al usuario la más satisfactoria experiencia de ducha.

Unique es una solución para el diseñador de la estancia de ducha, respaldada por especialistas en el producto, que permite alcanzar la máxima individualización.



Vista general del área privada de la vivienda desde la sala de baño. Al fondo se encuentra el dormitorio y vestidor en la zona central quedando al mismo anexo el área de ducha.



UNIQUE

la ducha
PLATOS DE DUCHA



Detalle en el que se muestra la resolución del plato de ducha según diseño del cliente y las transparencias creadas hacia la zona del vestidor.





Vista lateral desde el pasillo del plato de ducha con dimensiones extragrandes de 130 cm de anchura por 400 cm de longitud, realizado en Scene® blanco. Se ha optado por desaguado en borde y situar ranurados antideslizantes en la zona de entrada.



Ejemplo: plato de ducha de 90x165 cm con un desagüe en el borde del plato según indicaciones proporcionadas por el cliente

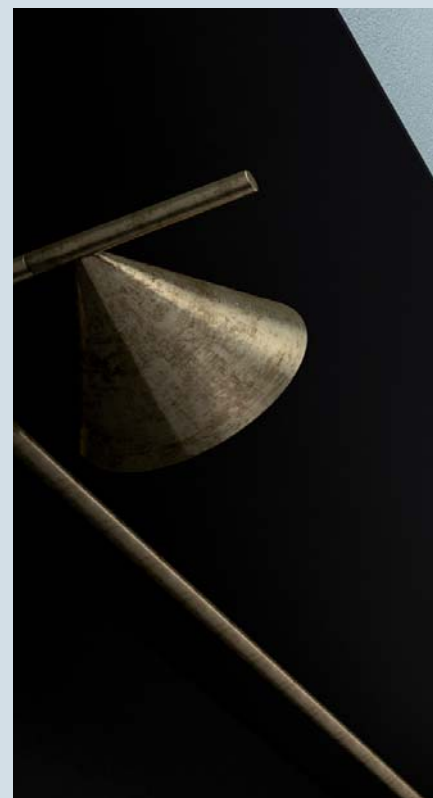
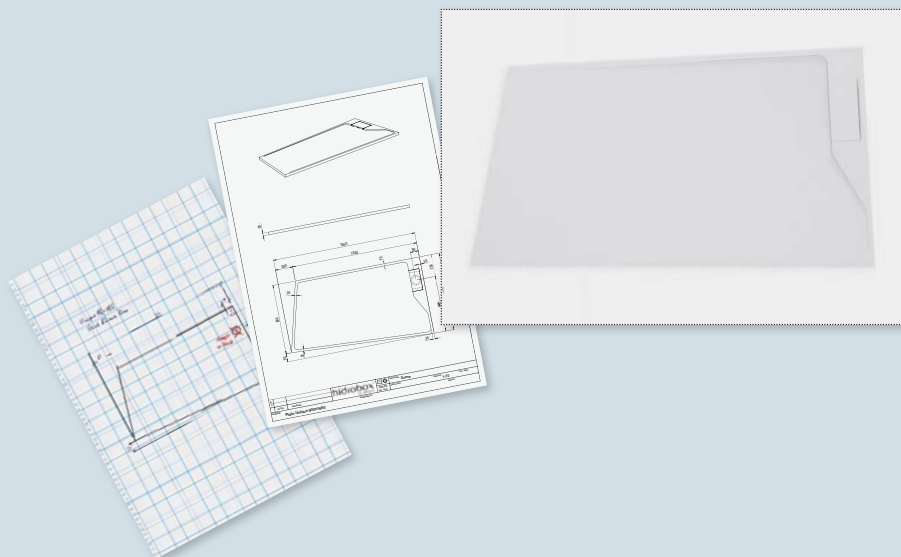



Ejemplo: plato de ducha de 100x325 cm compuesto por dos unidades coordinadas con desagüe en el borde del plato y ranurado según indicaciones proporcionadas por el cliente

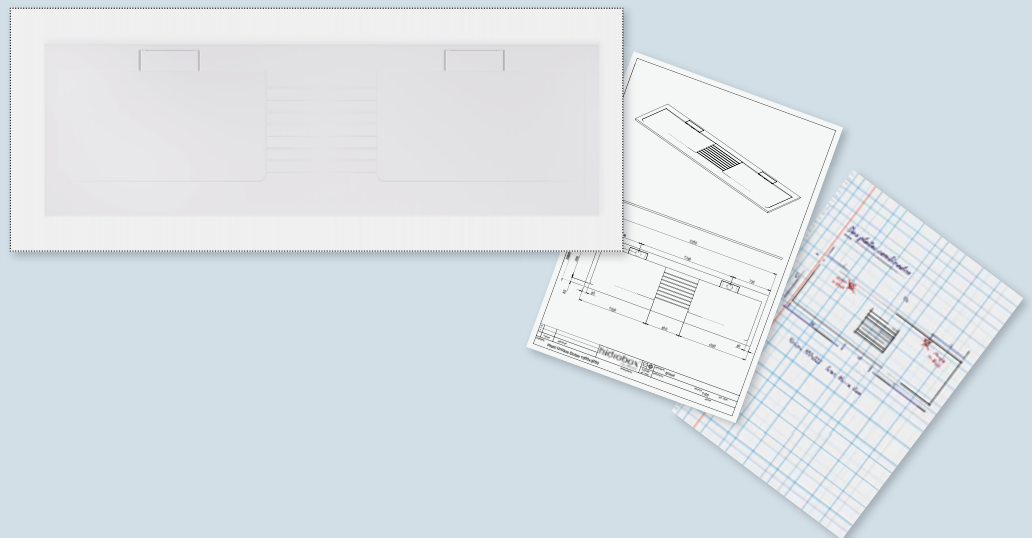

Ejemplo: plato de ducha de 90x120 cm con un desagüe a pared según indicaciones proporcionadas por el cliente

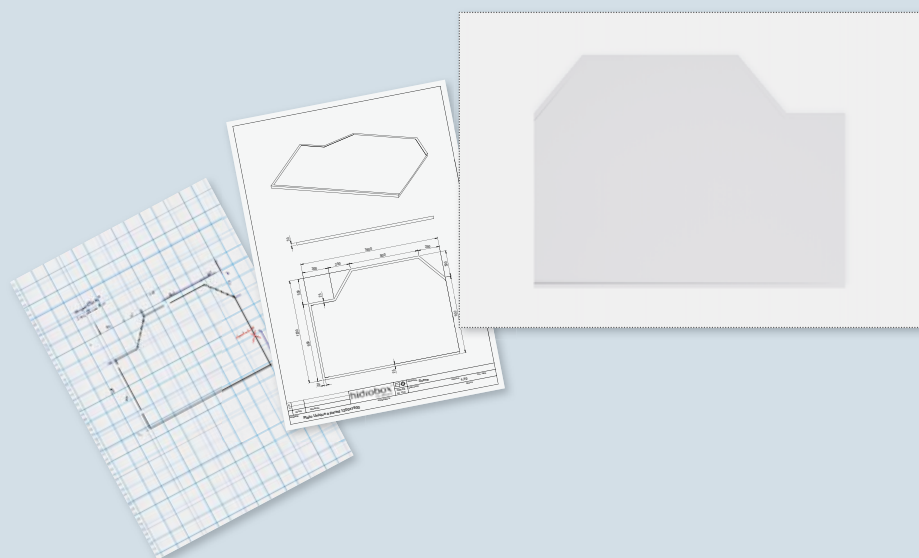



Ejemplo: plato de ducha de 130x180 cm con dos desagües en borde según indicaciones proporcionadas por el cliente

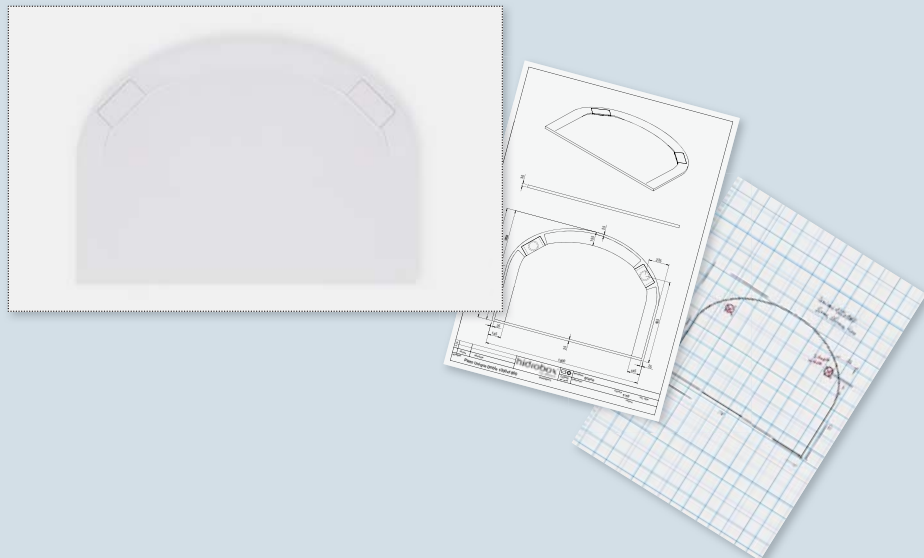

DESAGÜE A PARED

Plato de ducha realizado para desaguado a pared mediante canaleta mural.
Una vez diseñada la forma exterior del plato de ducha se identifica la longitud y la posición del desagüe en el perímetro. El plano inferior indica las distancias a respetar con respecto a las esquinas para la ubicación del canal de desaguado.

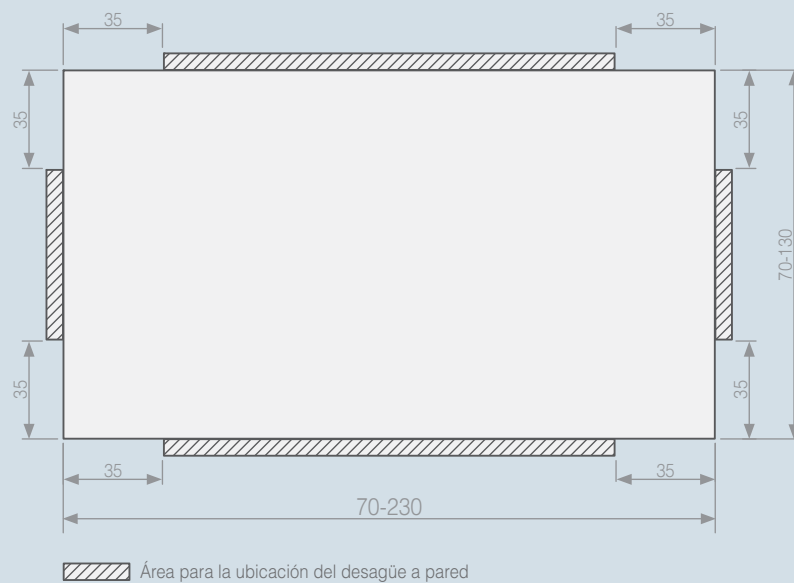
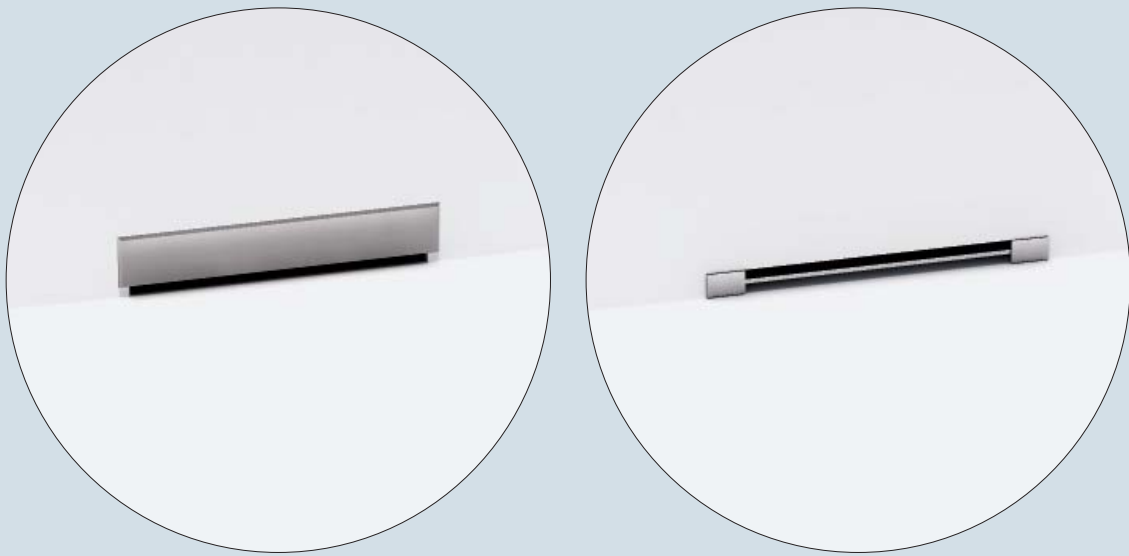

DESAGÜE EN BORDE

Plato de ducha realizado para desaguado a suelo en el borde.
Una vez diseñada la forma exterior del plato de ducha se identifica la posición del desagüe/s en el perímetro. El plano inferior indica las distancias a respetar con respecto a las esquinas para la ubicación del desagüe.

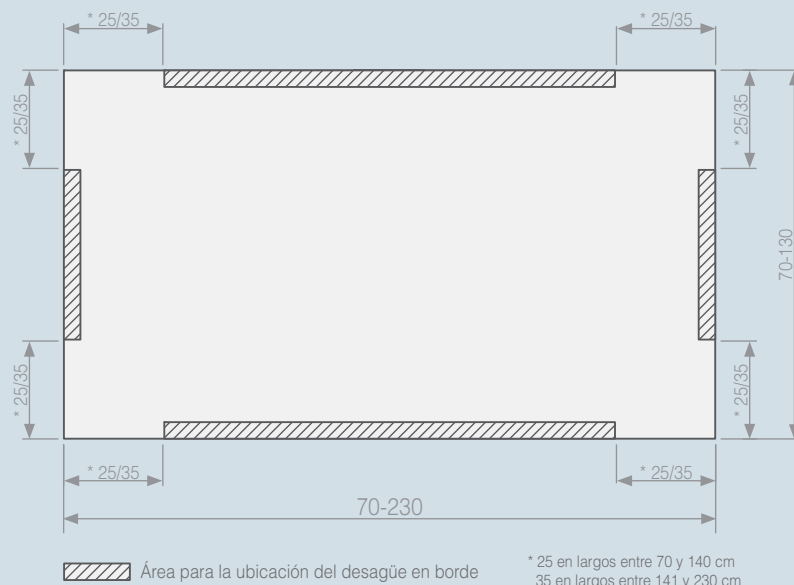

DESAGÜE EN INTERIOR

Plato de ducha realizado para desaguado en el interior.
Una vez diseñada la forma exterior del plato de ducha se identifica el tipo de desagüe y su posición en el interior. Los siguientes planos indican las zonas en las que es posible posicionar el desagüe/s según la dimensión del plato de ducha.

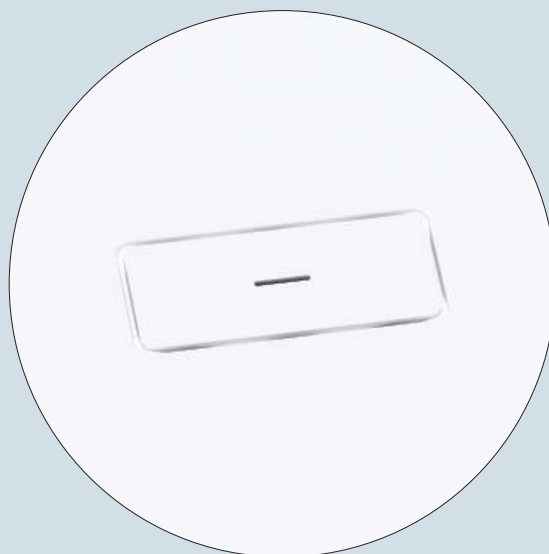

Tapa de desagüe rectangular del mismo material que el plato de ducha



Tapa de desagüe redonda

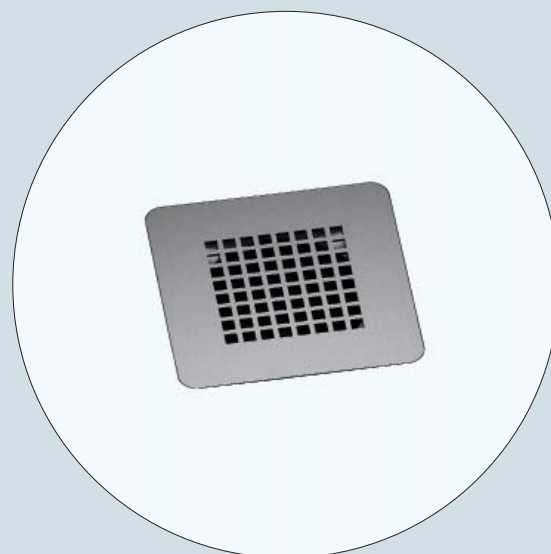

Tapa de desagüe cuadrada

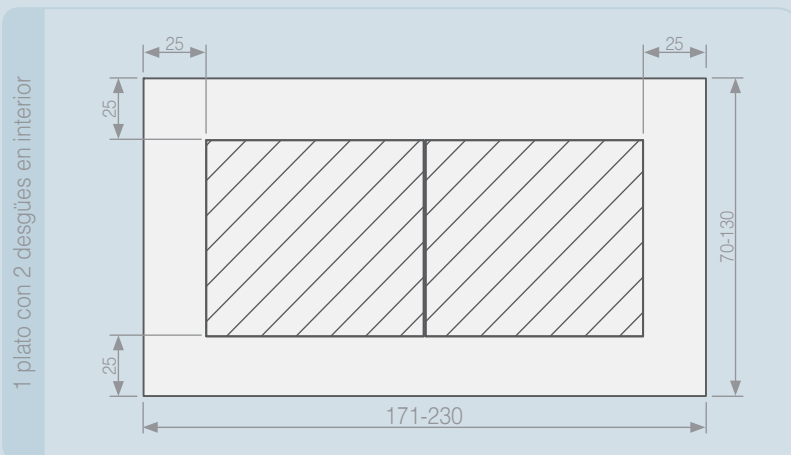
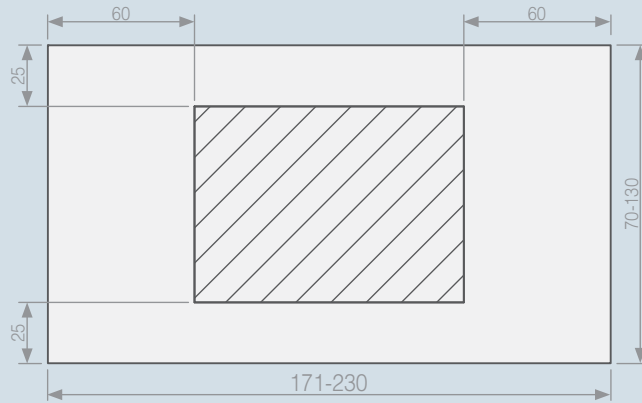
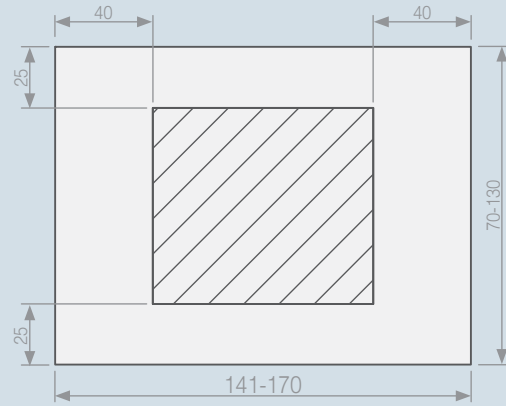
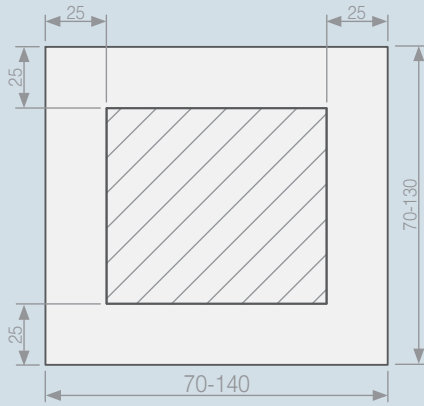

 Área para la ubicación del desagüe en interior

SOLUCIÓN PARA FORMATOS EXTRA GRANDES

Para alcanzar soluciones de plato de ducha en longitudes superiores a 230 cm y hasta 400 cm puede diseñar un espacio en base a dos unidades ensamblables de plato de ducha. Las dos unidades, de hasta 200 cm de longitud, se suministrarán independientes entre sí, pero coordinando su diseño para un correcto ensamblaje en destino.

Ejemplo de necesidad de solución extra grande de 100x325 cm

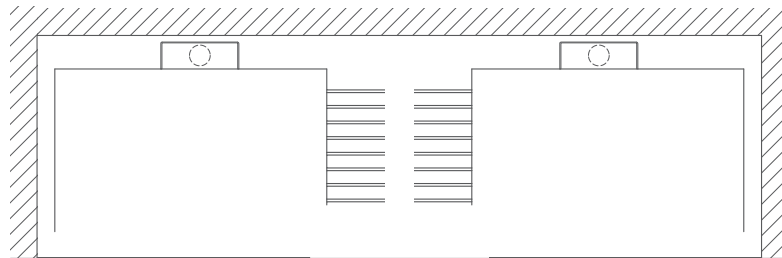

Pestañas de ensamblaje inferior en Unidad 1 y superior en Unidad 2 que determinan la secuencia de instalación.

La junta final de unión puede ser marcada a la vista, rejuntada mediante materiales genéricos, disimulada mediante el uso de los mismos materiales del plato de ducha.



Ejemplo 1



Ejemplo 2



Ejemplo 3

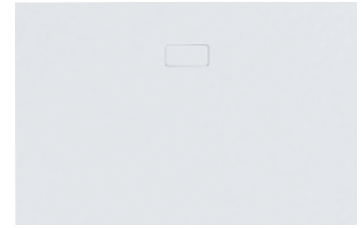

Ejemplo 4

ALTURA



30 mm

INSTALACIÓN



Sobre pavimento



Encastrado

TAPAS Y VÁLVULAS



Desaguado a pared para canaleta de ducha.
Suministro No incluido



Incluye Tapa en el mismo acabado que el plato en desagües en borde



Incluye Tapa en el mismo acabado que el plato en desagües en interior

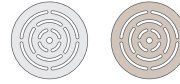

Incluye Rejilla redonda inox o del color del plato en desagües en interior

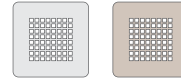

Incluye Rejilla cuadrada inox o del color del plato en desagües en interior

Incluida válvula (UNE EN-274) en desagües en borde y en interior















ACABADO SUPERFICIAL



Acabado textura lisa

Tratamiento Antislip Clase 3 (ENV 12633) | C (DIN 51097) | PN24 (XP P05-011). Incluido en Marmek®, opcional en Scene®

MATERIALES Y COLORES

Scene	marmek					
	COLOR BLANCO	COLOR STANDARD				COLOR SPECIAL
 BLANCO	 BIANCO	 PIETRA	 CAPPUCCINO	 GRIS	 IRON	 RAL* / NCS*
		 CREME	 TERRA	 CEMENT	 OMBRA	
		 BEIGE	 CACAO	 STEEL	 GRAPHITE	

		Scene	marmek		
		COLOR BLANCO textura lisa 	COLOR BIANCO textura lisa 	COLOR STANDARD textura lisa 	COLOR SPECIAL textura lisa
70	70-80	SUNC 0001	SUNC 0114	SUNC 0227	SUNC 0340
	81-90	SUNC 0002	SUNC 0115	SUNC 0228	SUNC 0341
	91-100	SUNC 0003	SUNC 0116	SUNC 0229	SUNC 0342
	101-110	SUNC 0004	SUNC 0117	SUNC 0230	SUNC 0343
	111-120	SUNC 0005	SUNC 0118	SUNC 0231	SUNC 0344
	121-130	SUNC 0006	SUNC 0119	SUNC 0232	SUNC 0345
	131-140	SUNC 0007	SUNC 0120	SUNC 0233	SUNC 0346
	141-150	SUNC 0008	SUNC 0121	SUNC 0234	SUNC 0347
	151-160	SUNC 0009	SUNC 0122	SUNC 0235	SUNC 0348
	161-170	SUNC 0010	SUNC 0123	SUNC 0236	SUNC 0349
	171-180	SUNC 0011	SUNC 0124	SUNC 0237	SUNC 0350
	181-190	SUNC 0012	SUNC 0125	SUNC 0238	SUNC 0351
	191-200	SUNC 0013	SUNC 0126	SUNC 0239	SUNC 0352
	201-210	SUNC 0014	SUNC 0127	SUNC 0240	SUNC 0353
	211-220	SUNC 0015	SUNC 0128	SUNC 0241	SUNC 0354
	221-230	SUNC 0016	SUNC 0129	SUNC 0242	SUNC 0355
71-75	71-80	SUNC 0017	SUNC 0130	SUNC 0243	SUNC 0356
	81-90	SUNC 0018	SUNC 0131	SUNC 0244	SUNC 0357
	91-100	SUNC 0019	SUNC 0132	SUNC 0245	SUNC 0358
	101-110	SUNC 0020	SUNC 0133	SUNC 0246	SUNC 0359
	111-120	SUNC 0021	SUNC 0134	SUNC 0247	SUNC 0360
	121-130	SUNC 0022	SUNC 0135	SUNC 0248	SUNC 0361
	131-140	SUNC 0023	SUNC 0136	SUNC 0249	SUNC 0362
	141-150	SUNC 0024	SUNC 0137	SUNC 0250	SUNC 0363
	151-160	SUNC 0025	SUNC 0138	SUNC 0251	SUNC 0364
	161-170	SUNC 0026	SUNC 0139	SUNC 0252	SUNC 0365
	171-180	SUNC 0027	SUNC 0140	SUNC 0253	SUNC 0366
	181-190	SUNC 0028	SUNC 0141	SUNC 0254	SUNC 0367
	191-200	SUNC 0029	SUNC 0142	SUNC 0255	SUNC 0368
	201-210	SUNC 0030	SUNC 0143	SUNC 0256	SUNC 0369
	211-220	SUNC 0031	SUNC 0144	SUNC 0257	SUNC 0370
	221-230	SUNC 0032	SUNC 0145	SUNC 0258	SUNC 0371

		Scene	marmek		
		COLOR BLANCO textura lisa <input type="text"/>	COLOR BIANCO textura lisa <input type="text"/>	COLOR STANDARD textura lisa <input type="text"/>	COLOR SPECIAL textura lisa <input type="text"/>
76-80	76-80	SUNC 0033	SUNC 0146	SUNC 0259	SUNC 0372
	81-90	SUNC 0034	SUNC 0147	SUNC 0260	SUNC 0373
	91-100	SUNC 0035	SUNC 0148	SUNC 0261	SUNC 0374
	101-110	SUNC 0036	SUNC 0149	SUNC 0262	SUNC 0375
	111-120	SUNC 0037	SUNC 0150	SUNC 0263	SUNC 0376
	121-130	SUNC 0038	SUNC 0151	SUNC 0264	SUNC 0377
	131-140	SUNC 0039	SUNC 0152	SUNC 0265	SUNC 0378
	141-150	SUNC 0040	SUNC 0153	SUNC 0266	SUNC 0379
	151-160	SUNC 0041	SUNC 0154	SUNC 0267	SUNC 0380
	161-170	SUNC 0042	SUNC 0155	SUNC 0268	SUNC 0381
	171-180	SUNC 0043	SUNC 0156	SUNC 0269	SUNC 0382
	181-190	SUNC 0044	SUNC 0157	SUNC 0270	SUNC 0383
	191-200	SUNC 0045	SUNC 0158	SUNC 0271	SUNC 0384
	201-210	SUNC 0046	SUNC 0159	SUNC 0272	SUNC 0385
	211-220	SUNC 0047	SUNC 0160	SUNC 0273	SUNC 0386
221-230	SUNC 0048	SUNC 0161	SUNC 0274	SUNC 0387	
81-90	81-90	SUNC 0049	SUNC 0162	SUNC 0275	SUNC 0388
	91-100	SUNC 0050	SUNC 0163	SUNC 0276	SUNC 0389
	101-110	SUNC 0051	SUNC 0164	SUNC 0277	SUNC 0390
	111-120	SUNC 0052	SUNC 0165	SUNC 0278	SUNC 0391
	121-130	SUNC 0053	SUNC 0166	SUNC 0279	SUNC 0392
	131-140	SUNC 0054	SUNC 0167	SUNC 0280	SUNC 0393
	141-150	SUNC 0055	SUNC 0168	SUNC 0281	SUNC 0394
	151-160	SUNC 0056	SUNC 0169	SUNC 0282	SUNC 0395
	161-170	SUNC 0057	SUNC 0170	SUNC 0283	SUNC 0396
	171-180	SUNC 0058	SUNC 0171	SUNC 0284	SUNC 0397
	181-190	SUNC 0059	SUNC 0172	SUNC 0285	SUNC 0398
	191-200	SUNC 0060	SUNC 0173	SUNC 0286	SUNC 0399
	201-210	SUNC 0061	SUNC 0174	SUNC 0287	SUNC 0400
	211-220	SUNC 0062	SUNC 0175	SUNC 0288	SUNC 0401
	221-230	SUNC 0063	SUNC 0176	SUNC 0289	SUNC 0402

		scene	marmek		
		COLOR BLANCO textura lisa <input type="checkbox"/>	COLOR BIANCO textura lisa <input type="checkbox"/>	COLOR STANDARD textura lisa <input type="checkbox"/>	COLOR SPECIAL textura lisa <input type="checkbox"/>
91-100	91-100	SUNC 0064	SUNC 0177	SUNC 0290	SUNC 0403
	101-110	SUNC 0065	SUNC 0178	SUNC 0291	SUNC 0404
	111-120	SUNC 0066	SUNC 0179	SUNC 0292	SUNC 0405
	121-130	SUNC 0067	SUNC 0180	SUNC 0293	SUNC 0406
	131-140	SUNC 0068	SUNC 0181	SUNC 0294	SUNC 0407
	141-150	SUNC 0069	SUNC 0182	SUNC 0295	SUNC 0408
	151-160	SUNC 0070	SUNC 0183	SUNC 0296	SUNC 0409
	161-170	SUNC 0071	SUNC 0184	SUNC 0297	SUNC 0410
	171-180	SUNC 0072	SUNC 0185	SUNC 0298	SUNC 0411
	181-190	SUNC 0073	SUNC 0186	SUNC 0299	SUNC 0412
	191-200	SUNC 0074	SUNC 0187	SUNC 0300	SUNC 0413
	201-210	SUNC 0075	SUNC 0188	SUNC 0301	SUNC 0414
	211-220	SUNC 0076	SUNC 0189	SUNC 0302	SUNC 0415
	221-230	SUNC 0077	SUNC 0190	SUNC 0303	SUNC 0416
101-110	101-110	SUNC 0078	SUNC 0191	SUNC 0304	SUNC 0417
	111-120	SUNC 0079	SUNC 0192	SUNC 0305	SUNC 0418
	121-130	SUNC 0080	SUNC 0193	SUNC 0306	SUNC 0419
	131-140	SUNC 0081	SUNC 0194	SUNC 0307	SUNC 0420
	141-150	SUNC 0082	SUNC 0195	SUNC 0308	SUNC 0421
	151-160	SUNC 0083	SUNC 0196	SUNC 0309	SUNC 0422
	161-170	SUNC 0084	SUNC 0197	SUNC 0310	SUNC 0423
	171-180	SUNC 0085	SUNC 0198	SUNC 0311	SUNC 0424
	181-190	SUNC 0086	SUNC 0199	SUNC 0312	SUNC 0425
	191-200	SUNC 0087	SUNC 0200	SUNC 0313	SUNC 0426
	201-210	SUNC 0088	SUNC 0201	SUNC 0314	SUNC 0427
	211-220	SUNC 0089	SUNC 0202	SUNC 0315	SUNC 0428
	221-230	SUNC 0090	SUNC 0203	SUNC 0316	SUNC 0429

		Scene	marmek		
		COLOR BLANCO textura lisa <input type="checkbox"/>	COLOR BIANCO textura lisa <input type="checkbox"/>	COLOR STANDARD textura lisa <input type="checkbox"/>	COLOR SPECIAL textura lisa <input type="checkbox"/>
111-120	111-120	SUNC 0091	SUNC 0204	SUNC 0317	SUNC 0430
	121-130	SUNC 0092	SUNC 0205	SUNC 0318	SUNC 0431
	131-140	SUNC 0093	SUNC 0206	SUNC 0319	SUNC 0432
	141-150	SUNC 0094	SUNC 0207	SUNC 0320	SUNC 0433
	151-160	SUNC 0095	SUNC 0208	SUNC 0321	SUNC 0434
	161-170	SUNC 0096	SUNC 0209	SUNC 0322	SUNC 0435
	171-180	SUNC 0097	SUNC 0210	SUNC 0323	SUNC 0436
	181-190	SUNC 0098	SUNC 0211	SUNC 0324	SUNC 0437
	191-200	SUNC 0099	SUNC 0212	SUNC 0325	SUNC 0438
	201-210	SUNC 0100	SUNC 0213	SUNC 0326	SUNC 0439
	211-220	SUNC 0101	SUNC 0214	SUNC 0327	SUNC 0440
	221-230	SUNC 0102	SUNC 0215	SUNC 0328	SUNC 0441
	121-130	121-130	SUNC 0103	SUNC 0216	SUNC 0329
131-140		SUNC 0104	SUNC 0217	SUNC 0330	SUNC 0443
141-150		SUNC 0105	SUNC 0218	SUNC 0331	SUNC 0444
151-160		SUNC 0106	SUNC 0219	SUNC 0332	SUNC 0445
161-170		SUNC 0107	SUNC 0220	SUNC 0333	SUNC 0446
171-180		SUNC 0108	SUNC 0221	SUNC 0334	SUNC 0447
181-190		SUNC 0109	SUNC 0222	SUNC 0335	SUNC 0448
191-200		SUNC 0110	SUNC 0223	SUNC 0336	SUNC 0449
201-210		SUNC 0111	SUNC 0224	SUNC 0337	SUNC 0450
211-220		SUNC 0112	SUNC 0225	SUNC 0338	SUNC 0451
221-230		SUNC 0113	SUNC 0226	SUNC 0339	SUNC 0452

BOCETO UNIQUE

Dibujar el plato de ducha deseado incluyendo cotas, número de desagües y su posición.
Los pedidos serán confirmados mediante plano técnico elaborado por Hidrobox.

UNIQUE
código

ancho x largo

material
 Scene®
 Marmek®

color
 Scene®
 blanco
 Marmek®
 blanco
 standard
 special

textura
 liso

TIPO DE DESAGÜE

A PARED



Desaguado a pared para canaleta de ducha, como por ejemplo Viega Advantix Vario (art. 736736) o Geberit Duofix (art. 111.593.00.1).
Suministro No incluido.

EN BORDE



incluido Tapa en el mismo acabado que el plato de ducha

EN INTERIOR



incluido Tapa en el mismo acabado que el plato de ducha



incluido Rejilla redonda inox o del mismo color que el plato de ducha



incluido Rejilla cuadrada inox o del mismo color que el plato de ducha

NÚMERO DE DESAGÜES

incluido 1 Desagüe

+ 2 Desagües

VÁLVULA

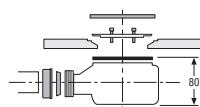

incluido Válvula salida horizontal Viega 90 Tempoplex
Según norma EN-274
Para desagües en borde o en interior

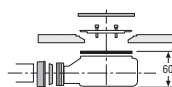

incluido Válvula salida horizontal Viega 90 Tempoplex extraplana
Para desagües en borde o en interior

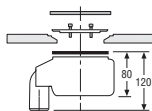

incluido Válvula salida vertical Viega 90 Tempoplex
Según norma EN-274
Para desagües en borde o en interior

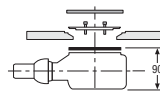

incluido Válvula salida horizontal Viega 90 Tempoplex Plus
Para desagües en borde o en interior

TRATAMIENTO ANTISLIP



incluido Tratamiento Antislip Clase 3 ENV 12633 | C (DIN 51097) | PN24 (XP P05-011), para Marmek®



+ Tratamiento Antislip Clase 3 ENV 12633 | C (DIN 51097) | PN24 (XP P05-011), para Scene®

la ducha
PLATOS DE DUCHA

SELECT







La serie Select ofrece un amplio programa de formas interiores para diseñar un plato de ducha.

Esta serie está destinada para que el diseñador de un espacio de ducha pueda configurar una solución singular y adecuada a sus necesidades. El diseñador, una vez determinada la forma exterior del plato de ducha pasa a seleccionar la forma o formas predefinidas en su interior y su posición y orientación.

Select es una ayuda al diseñador, al que le otorga libertad para encontrar soluciones ante formas complejas.

la ducha
PLATOS DE DUCHA

SELECT

SELECT

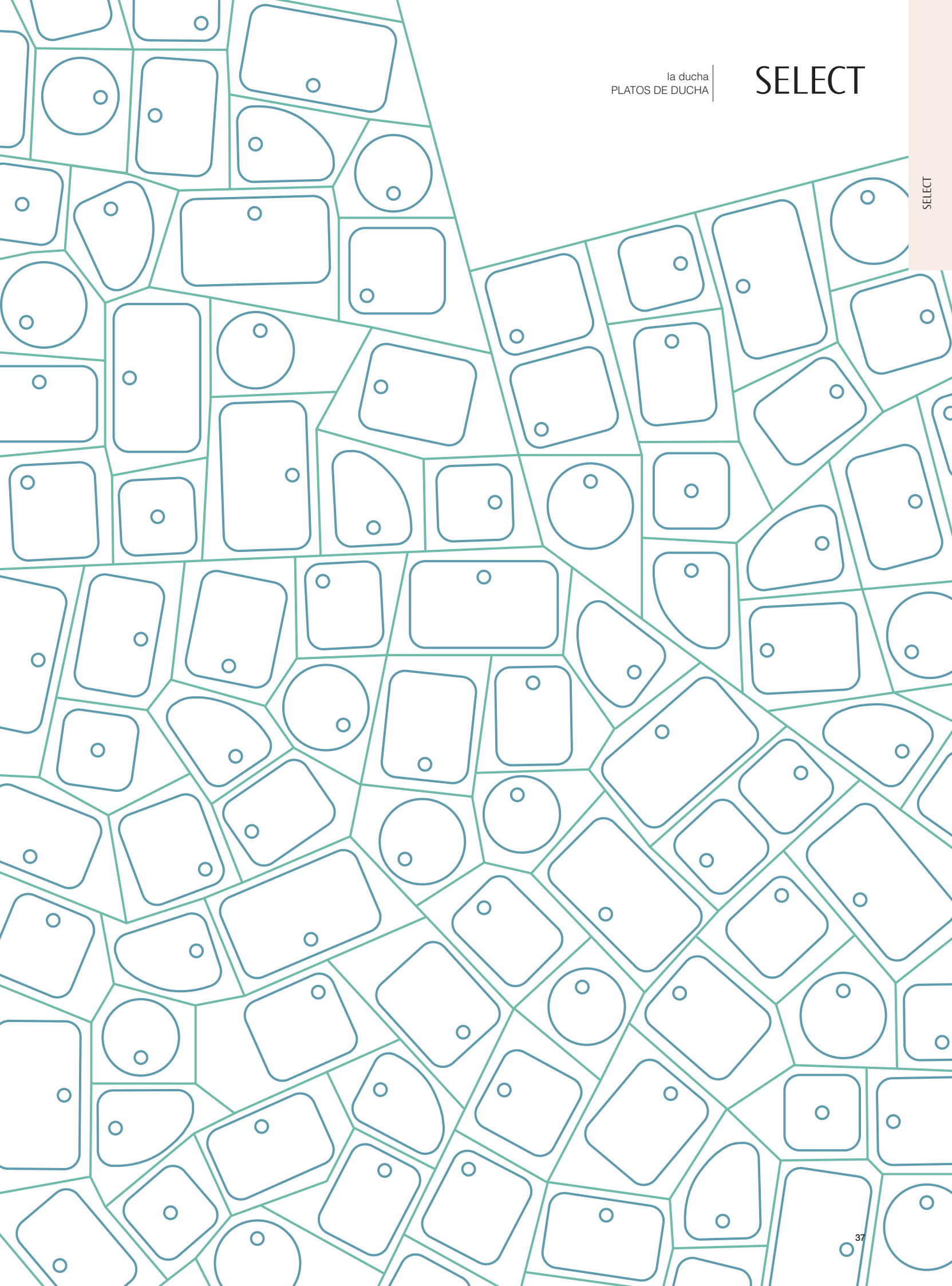

FORMAS INTERIORES DE PLATO PARA ELEGIR

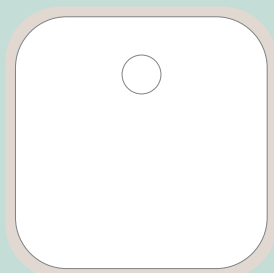

S1 74x74
Mínimo 80x80



S2 84x84
Mínimo 90x90

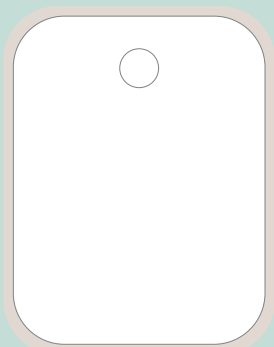

S3 74x94
Mínimo 80x100

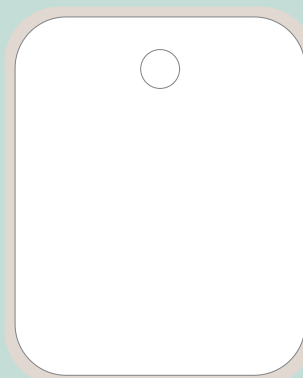

S4 84x104
Mínimo 90x110



S5 74x74
Mínimo 80x80



S6 74x84
Mínimo 80x90



S7 84x94
Mínimo 90x100

La distancia del centro del desagüe al borde más próximo del seno es de 17 cm, salvo en S5 que está centrado

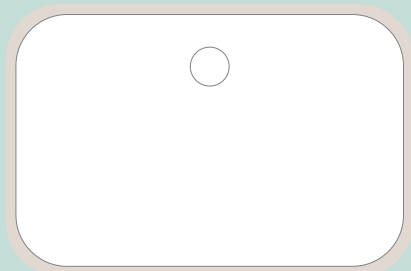

S8 74x114
Mínimo 80x120

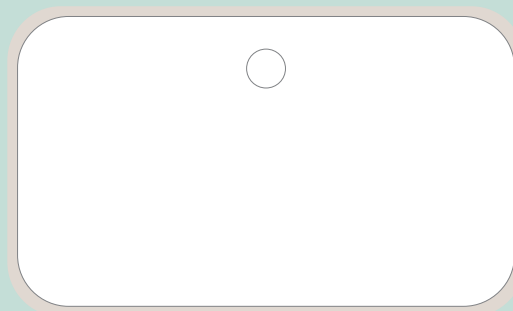

S9 84x144
Mínimo 90x150

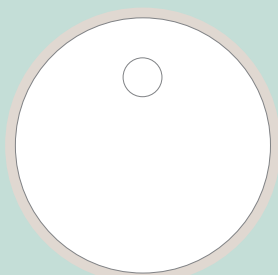

S10 Ø74
Mínimo Ø80

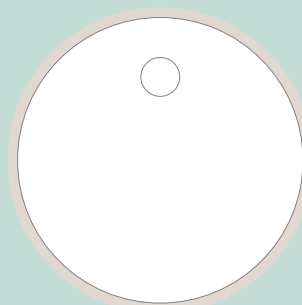

S11 Ø84
Mínimo Ø90

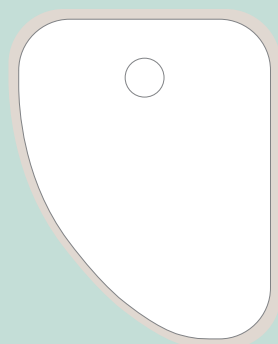

S12 74x94
Mínimo 80x100

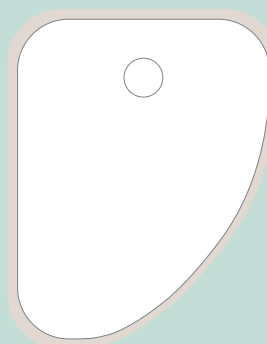

S13 74x94
Mínimo 80x100

Para alcanzar soluciones de plato de ducha en longitudes superiores a 230 cm y hasta 400 cm puede diseñar un espacio en base a dos unidades ensamblables de plato de ducha. Las dos unidades, de hasta 200 cm de longitud, se suministrarán independientes entre sí, pero coordinando su diseño para un correcto ensamblaje en el destino (ver solución similar en página 26 de la serie Unique).

SELECT

la ducha
PLATOS DE DUCHA



Detalle SELECT 80x80 blanco, acabado textura lisa



Ejemplo 1

Ejemplo 2

Ejemplo 3

Ejemplo 4

ALTURA



30 mm

INSTALACIÓN



Sobre pavimento



Encastrado

REJILLAS Y VÁLVULAS

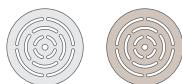

Incluye rejilla redonda inox
Opcional del mismo color que el plato

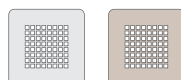

Incluye rejilla cuadrada inox o
del mismo color que el plato

Incluida válvula Ø90 (UNE EN-274)
Posibilidad de instalar con
otras válvulas de Ø90















ACABADO SUPERFICIAL



Acabado textura lisa

Tratamiento Antislip Clase 3 (ENV 12633) | C (DIN 51097) | PN24 (XP P05-011). Incluido en Marmek®, opcional en Scene®

MATERIALES Y COLORES

Scene	marmek					
	COLOR BLANCO	COLOR STANDARD				COLOR SPECIAL
 BLANCO	 BIANCO	 PIETRA	 CAPPUCCINO	 GRIS	 IRON	 RAL* / NCS*
		 CREME	 TERRA	 CEMENT	 OMBRA	
		 BEIGE	 CACAO	 STEEL	 GRAPHITE	

SELECT

la ducha
PLATOS DE DUCHA
tarifa

		scene	marmek		
		COLOR BLANCO textura lisa <input type="text"/>	COLOR BIANCO textura lisa <input type="text"/>	COLOR STANDARD textura lisa <input type="text"/>	COLOR SPECIAL textura lisa <input type="text"/>
80	80-90	SSEC 0001	SSEC 0081	SSEC 0161	SSEC 0241
	91-100	SSEC 0002	SSEC 0082	SSEC 0162	SSEC 0242
	101-110	SSEC 0003	SSEC 0083	SSEC 0163	SSEC 0243
	111-120	SSEC 0004	SSEC 0084	SSEC 0164	SSEC 0244
	121-130	SSEC 0005	SSEC 0085	SSEC 0165	SSEC 0245
	131-140	SSEC 0006	SSEC 0086	SSEC 0166	SSEC 0246
	141-150	SSEC 0007	SSEC 0087	SSEC 0167	SSEC 0247
	151-160	SSEC 0008	SSEC 0088	SSEC 0168	SSEC 0248
	161-170	SSEC 0009	SSEC 0089	SSEC 0169	SSEC 0249
	171-180	SSEC 0010	SSEC 0090	SSEC 0170	SSEC 0250
	181-190	SSEC 0011	SSEC 0091	SSEC 0171	SSEC 0251
	191-200	SSEC 0012	SSEC 0092	SSEC 0172	SSEC 0252
	201-210	SSEC 0013	SSEC 0093	SSEC 0173	SSEC 0253
	211-220	SSEC 0014	SSEC 0094	SSEC 0174	SSEC 0254
	221-230	SSEC 0015	SSEC 0095	SSEC 0175	SSEC 0255
81-90	81-90	SSEC 0016	SSEC 0096	SSEC 0176	SSEC 0256
	91-100	SSEC 0017	SSEC 0097	SSEC 0177	SSEC 0257
	101-110	SSEC 0018	SSEC 0098	SSEC 0178	SSEC 0258
	111-120	SSEC 0019	SSEC 0099	SSEC 0179	SSEC 0259
	121-130	SSEC 0020	SSEC 0100	SSEC 0180	SSEC 0260
	131-140	SSEC 0021	SSEC 0101	SSEC 0181	SSEC 0261
	141-150	SSEC 0022	SSEC 0102	SSEC 0182	SSEC 0262
	151-160	SSEC 0023	SSEC 0103	SSEC 0183	SSEC 0263
	161-170	SSEC 0024	SSEC 0104	SSEC 0184	SSEC 0264
	171-180	SSEC 0025	SSEC 0105	SSEC 0185	SSEC 0265
	181-190	SSEC 0026	SSEC 0106	SSEC 0186	SSEC 0266
	191-200	SSEC 0027	SSEC 0107	SSEC 0187	SSEC 0267
	201-210	SSEC 0028	SSEC 0108	SSEC 0188	SSEC 0268
	211-220	SSEC 0029	SSEC 0109	SSEC 0189	SSEC 0269
	221-230	SSEC 0030	SSEC 0110	SSEC 0190	SSEC 0270

		Scene		marmek	
		COLOR BLANCO	COLOR BIANCO	COLOR STANDARD	COLOR SPECIAL
		textura lisa	textura lisa	textura lisa	textura lisa
		<input type="text"/>	<input type="text"/>	<input type="text"/>	<input type="text"/>
91-100	91-100	SSEC 0031	SSEC 0111	SSEC 0191	SSEC 0271
	101-110	SSEC 0032	SSEC 0112	SSEC 0192	SSEC 0272
	111-120	SSEC 0033	SSEC 0113	SSEC 0193	SSEC 0273
	121-130	SSEC 0034	SSEC 0114	SSEC 0194	SSEC 0274
	131-140	SSEC 0035	SSEC 0115	SSEC 0195	SSEC 0275
	141-150	SSEC 0036	SSEC 0116	SSEC 0196	SSEC 0276
	151-160	SSEC 0037	SSEC 0117	SSEC 0197	SSEC 0277
	161-170	SSEC 0038	SSEC 0118	SSEC 0198	SSEC 0278
	171-180	SSEC 0039	SSEC 0119	SSEC 0199	SSEC 0279
	181-190	SSEC 0040	SSEC 0120	SSEC 0200	SSEC 0280
	191-200	SSEC 0041	SSEC 0121	SSEC 0201	SSEC 0281
	201-210	SSEC 0042	SSEC 0122	SSEC 0202	SSEC 0282
	211-220	SSEC 0043	SSEC 0123	SSEC 0203	SSEC 0283
	221-230	SSEC 0044	SSEC 0124	SSEC 0204	SSEC 0284
101-110	101-110	SSEC 0045	SSEC 0125	SSEC 0205	SSEC 0285
	111-120	SSEC 0046	SSEC 0126	SSEC 0206	SSEC 0286
	121-130	SSEC 0047	SSEC 0127	SSEC 0207	SSEC 0287
	131-140	SSEC 0048	SSEC 0128	SSEC 0208	SSEC 0288
	141-150	SSEC 0049	SSEC 0129	SSEC 0209	SSEC 0289
	151-160	SSEC 0050	SSEC 0130	SSEC 0210	SSEC 0290
	161-170	SSEC 0051	SSEC 0131	SSEC 0211	SSEC 0291
	171-180	SSEC 0052	SSEC 0132	SSEC 0212	SSEC 0292
	181-190	SSEC 0053	SSEC 0133	SSEC 0213	SSEC 0293
	191-200	SSEC 0054	SSEC 0134	SSEC 0214	SSEC 0294
	201-210	SSEC 0055	SSEC 0135	SSEC 0215	SSEC 0295
	211-220	SSEC 0056	SSEC 0136	SSEC 0216	SSEC 0296
	221-230	SSEC 0057	SSEC 0137	SSEC 0217	SSEC 0297

SELECT

la ducha
PLATOS DE DUCHA
tarifa

		scene	marmek		
		COLOR BLANCO textura lisa <input type="text"/>	COLOR BIANCO textura lisa <input type="text"/>	COLOR STANDARD textura lisa <input type="text"/>	COLOR SPECIAL textura lisa <input type="text"/>
111-120	111-120	SSEC 0058	SSEC 0138	SSEC 0218	SSEC 0298
	121-130	SSEC 0059	SSEC 0139	SSEC 0219	SSEC 0299
	131-140	SSEC 0060	SSEC 0140	SSEC 0220	SSEC 0300
	141-150	SSEC 0061	SSEC 0141	SSEC 0221	SSEC 0301
	151-160	SSEC 0062	SSEC 0142	SSEC 0222	SSEC 0302
	161-170	SSEC 0063	SSEC 0143	SSEC 0223	SSEC 0303
	171-180	SSEC 0064	SSEC 0144	SSEC 0224	SSEC 0304
	181-190	SSEC 0065	SSEC 0145	SSEC 0225	SSEC 0305
	191-200	SSEC 0066	SSEC 0146	SSEC 0226	SSEC 0306
	201-210	SSEC 0067	SSEC 0147	SSEC 0227	SSEC 0307
	211-220	SSEC 0068	SSEC 0148	SSEC 0228	SSEC 0308
	221-230	SSEC 0069	SSEC 0149	SSEC 0229	SSEC 0309
	121-130	121-130	SSEC 0070	SSEC 0150	SSEC 0230
131-140		SSEC 0071	SSEC 0151	SSEC 0231	SSEC 0311
141-150		SSEC 0072	SSEC 0152	SSEC 0232	SSEC 0312
151-160		SSEC 0073	SSEC 0153	SSEC 0233	SSEC 0313
161-170		SSEC 0074	SSEC 0154	SSEC 0234	SSEC 0314
171-180		SSEC 0075	SSEC 0155	SSEC 0235	SSEC 0315
181-190		SSEC 0076	SSEC 0156	SSEC 0236	SSEC 0316
191-200		SSEC 0077	SSEC 0157	SSEC 0237	SSEC 0317
201-210		SSEC 0078	SSEC 0158	SSEC 0238	SSEC 0318
211-220		SSEC 0079	SSEC 0159	SSEC 0239	SSEC 0319
221-230		SSEC 0080	SSEC 0160	SSEC 0240	SSEC 0320

OPCIONES DEL PRODUCTO E INFORMACIÓN TÉCNICA IMPORTANTE

la ducha
PLATOS DE DUCHA
tarifa

SELECT

SELECT

SELECT código

ancho x largo

material

- Scene®
- Marmek®

color

- Scene®
- blanco
- Marmek®
- blanco
- standard
- special

textura

- liso

NÚMERO Y TIPO DE SENO

incluido 1 Seno

+ 2 Senos

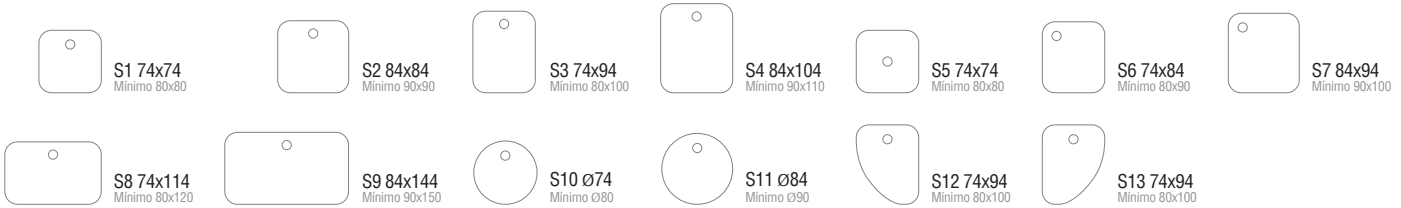

POSICIÓN DEL SENO

Dibujar plato de ducha acotado teniendo en cuenta las siguientes pautas de diseño:

- Área máxima 130x230 cm
- Distancia mínima entre seno y borde 3 cm
- Distancia mínima entre seno y seno 6 cm



Los pedidos serán confirmados mediante plano técnico

RANURADO



+ Ranuras para desaguado de zonas planas
Para áreas a partir de 20x20 cm. Se confirmará diseño en plano técnico

REJILLA VÁLVULA



incluido Rejilla redonda inox



incluido Rejilla cuadrada inox



incluido Rejilla redonda con el mismo color que el plato de ducha



incluido Rejilla cuadrada con el mismo color que el plato de ducha

VÁLVULA

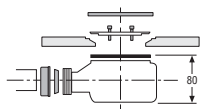

incluido Válvula salida horizontal Viega 90 Tempoplex
Según norma EN-274

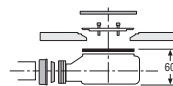

incluido Válvula salida horizontal Viega 90 Tempoplex extraplana

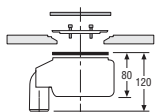

incluido Válvula salida vertical Viega 90 Tempoplex
Según norma EN-274

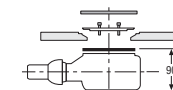

incluido Válvula salida horizontal Viega 90 Tempoplex Plus

TRATAMIENTO ANTISLIP



incluido Tratamiento Antislip Clase 3 ENV 12633 | C (DIN 51097) | PN24 (XP P05-011), para Marmek®



+ Tratamiento Antislip Clase 3 ENV 12633 | C (DIN 51097) | PN24 (XP P05-011), para Scene®

la ducha
PLATOS DE DUCHA

STUDIO PLUS



STUDIO PLUS 70x150 blanco, acabado textura lisa



STUDIO PLUS

la ducha
PLATOS DE DUCHA



STUDIO PLUS 70x150 blanco, acabado textura lisa



STUDIO PLUS 70x150 blanco, acabado textura lisa



ALTURA



40 mm

INSTALACIÓN



Sobre pavimento



Encastrado

TAPAS Y VÁLVULAS

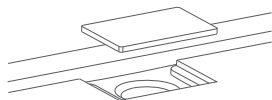

Incluida tapa de Scene®
para desagüe

Incluida válvula Ø90 (UNE EN-274)
Posibilidad de instalar con
otras válvulas de Ø90

ACABADO SUPERFICIAL



Acabado textura lisa

Tratamiento Antislip Clase 3 (ENV 12633) | C (DIN 51097) | PN24 (XP P05-011), opcional

MATERIAL Y COLOR

Scene



BLANCO

STUDIO PLUS

la ducha
PLATOS DE DUCHA
tarifa

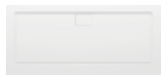

Rectangular



		STUDIO PLUS	
		Scene	
		COLOR BLANCO	
		textura lisa	
		<input type="text"/>	
70	120-130		SSTC 0001
	131-140		SSTC 0002
	150-160		SSTC 0003
	161-170		SSTC 0004
	171-180		SSTC 0005
	181-190		SSTC 0006
71-75	120-130		SSTC 0007
	131-140		SSTC 0008
	150-160		SSTC 0009
	161-170		SSTC 0010
	171-180		SSTC 0011
	181-190		SSTC 0012
76-80	120-130		SSTC 0013
	131-140		SSTC 0014
	150-160		SSTC 0015
	161-170		SSTC 0016
	171-180		SSTC 0017
	181-190		SSTC 0018

STUDIO PLUS

código



ancho

x



largo

material

□ Scene®

color

□ blanco

textura

□ liso

forma

□ rectangular

TAPA VÁLVULA



incluido Tapa para válvula rectangular en Scene®

VÁLVULA

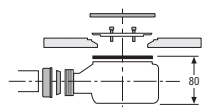

incluido Válvula salida horizontal Viega 90 Tempoplex
Según norma EN-274

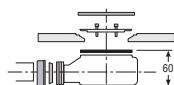

+ Válvula salida horizontal Viega 90 Tempoplex extraplana

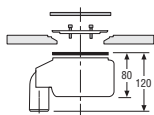

+ Válvula salida vertical Viega 90 Tempoplex
Según norma EN-274

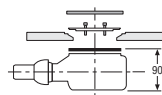

+ Válvula salida horizontal Viega 90 Tempoplex Plus

TRATAMIENTO ANTISLIP

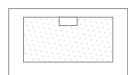

+ Tratamiento Antislip Clase 3 ENV 12633 |
C (DIN 51097) | PN24 (XP P05-011), para Scene®

CORTE



incluido Cortes longitudinales en ancho y largo cm a cm

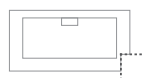

+ Cortes especiales cm a cm

Los pedidos serán confirmados mediante plano técnico



STUDIO PLUS

la ducha
PLATOS DE DUCHA
información técnica



STUDIO PLUS 70x150 blanco, acabado textura lisa

PLATO DE DUCHA STUDIO PLUS / STUDIO PLUS SHOWER TRAY / RECEVEUR DE DOUCHE STUDIO PLUS / BASE DE CHUVEIRO STUDIO PLUS

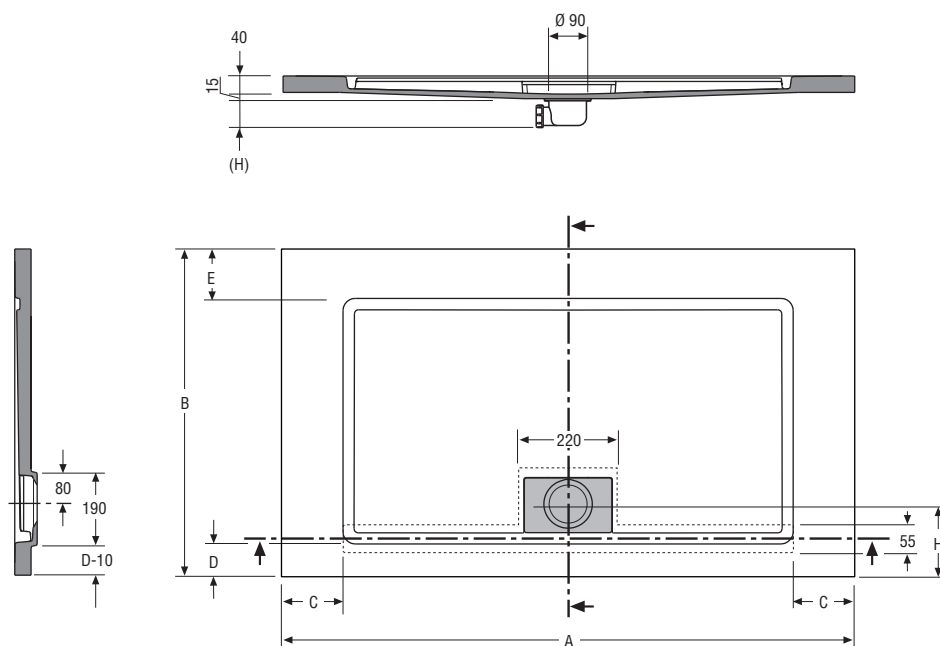
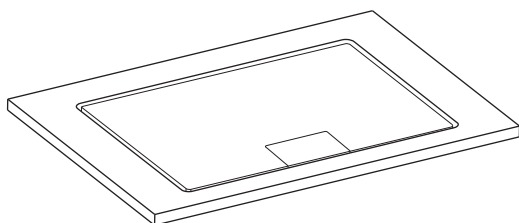

A	B	C	D	E	H	V	P
1200	700	50	50	50	148	0'124	66
1210 → 1300	700	100	50	50	148	0'124	68
1310 → 1400	700	150	50	50	148	0'132	74
1500 → 1600	700	100	50	50	148	0'150	79
1610 → 1700	700	150	50	50	148	0'158	85
1710 → 1800	700	100	50	50	148	0'167	92
1810 → 1900	700	150	50	50	148	0'176	98

A	B	C	D	E	H	V	P
1200	750	50	80	70	178	0'124	70
1210 → 1300	750	100	80	70	178	0'124	72
1310 → 1400	750	150	80	70	178	0'132	79
1500 → 1600	750	100	80	70	178	0'150	87
1610 → 1700	750	150	80	70	178	0'158	94
1710 → 1800	750	100	80	70	178	0'167	98
1810 → 1900	750	150	80	70	178	0'176	105

A	B	C	D	E	H	V	P
1200	800	50	80	120	178	0'131	76
1210 → 1300	800	100	80	120	178	0'131	78
1310 → 1400	800	150	80	120	178	0'140	85
1500 → 1600	800	100	80	120	178	0'158	94
1610 → 1700	800	150	80	120	178	0'167	101
1710 → 1800	800	100	80	120	178	0'177	106
1810 → 1900	800	150	80	120	178	0'189	113

Medidas en mm / Sizes in mm / Mesures en mm/ Medidas em mm

V Volumen de expedición sin palet (m3) | Shipping volume without palet | Volume à l'expédition sans palet | Volume expedição sin palet
P Peso de expedición sin palet (Kg) | Shipping weight without palet | Poids à l'expédition sans palet | Peso de expedição sin palet

(H) Medida en función del desagüe suministrado | Height according to valve supplied | Mesure en fonction du vidage livré | Medida em função da válvula fornecida

la ducha
PLATOS DE DUCHA

ZONE

ZONE 80x160 blanco, acabado textura lisa





ZONE 80x140 blanco, acabado textura lisa

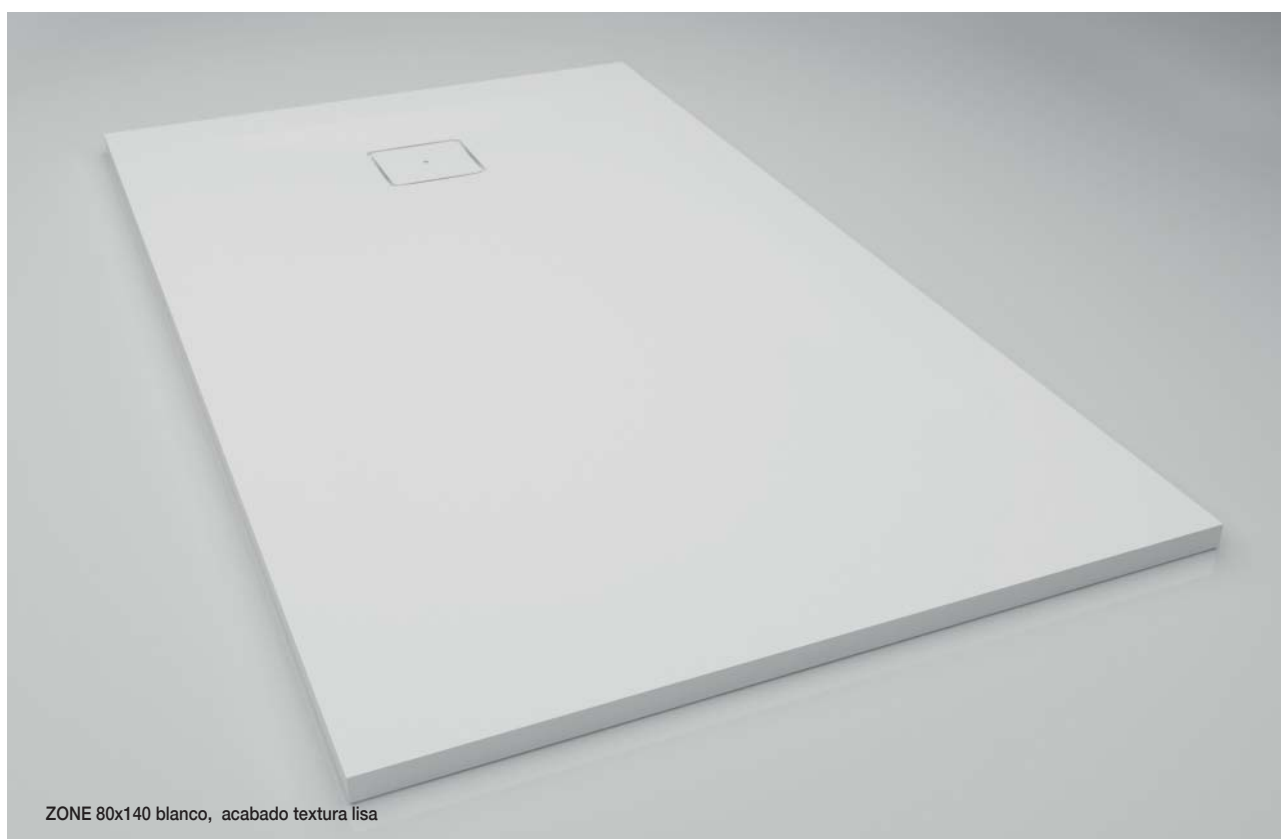

ZONE 80x140 blanco, acabado textura lisa

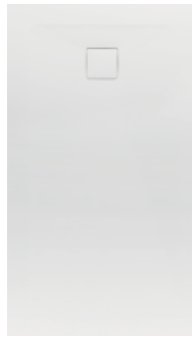

ALTURA



25 mm

INSTALACIÓN



Sobre pavimento



Encastrado

TAPAS Y VÁLVULAS



Incluida tapa de Scene®
para desagüe

Incluida válvula Ø90 (UNE EN-274)
Posibilidad de instalar con
otras válvulas de Ø90

ACABADO SUPERFICIAL



Acabado textura lisa

Tratamiento Antislip Clase 3 (ENV 12633) | C (DIN 51097) | PN24 (XP P05-011), opcional

MATERIAL Y COLOR

Scene



BLANCO

ZONE

la ducha
PLATOS DE DUCHA
tarifa

		ZONE	
		Scene	
		COLOR BLANCO	
		textura lisa	
		<input type="text"/>	
70	100-110		SZOC 0001
	111-120		SZOC 0002
	121-130		SZOC 0003
	131-140		SZOC 0004
	141-150		SZOC 0005
	151-160		SZOC 0006
	161-170		SZOC 0007
71-75	100-110		SZOC 0008
	111-120		SZOC 0009
	121-130		SZOC 0010
	131-140		SZOC 0011
	141-150		SZOC 0012
	151-160		SZOC 0013
	161-170		SZOC 0014
76-80	100-110		SZOC 0015
	111-120		SZOC 0016
	121-130		SZOC 0017
	131-140		SZOC 0018
	141-150		SZOC 0019
	151-160		SZOC 0020
	161-170		SZOC 0021
80-90	120-130		SZOC 0022
	131-140		SZOC 0023
91-100	120-130		SZOC 0024
	131-140		SZOC 0025

Rectangular R		Rectangular L	
ZONE			
Scene			
COLOR BLANCO			
textura lisa			
90-100	100-110	SZOC 0026	
	111-120	SZOC 0027	
90-100	100-110	SZOC 0028	
	111-120	SZOC 0029	

ZONE código ancho x largo material color textura forma

Scene® blanco liso rectangular
 rectangular C rectangular R rectangular L

TAPA VÁLVULA

incluido Tapa para válvula cuadrada en Scene®

VÁLVULA

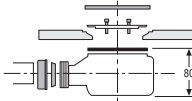
 **incluido** Válvula salida horizontal Viega 90 Tempoplex
Según norma EN-274

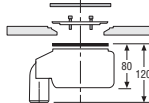
 + Válvula salida vertical Viega 90 Tempoplex
Según norma EN-274

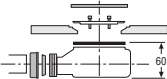
 + Válvula salida horizontal Viega 90 Tempoplex extraplana

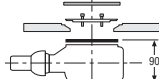

 + Válvula salida horizontal Viega 90 Tempoplex Plus

TRATAMIENTO ANTISLIP

+ Tratamiento Antislip Clase 3 ENV 12633 | C (DIN 51097) | PN24 (XP P05-011), para Scene®

CORTE

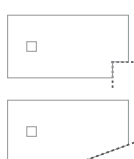
 **incluido** Cortes longitudinales en ancho y largo cm a cm

 + Cortes especiales cm a cm
Los pedidos serán confirmados mediante plano técnico 

ZONE

la ducha
PLATOS DE DUCHA
información técnica

PLATO DE DUCHA ZONE RECTANGULAR / ZONE RECTANGULAR SHOWER TRAY / RECEVEUR DE DOUCHE ZONE RECTANGULAIRE / BASE DE CHUVEIRO ZONE RETANGULAR

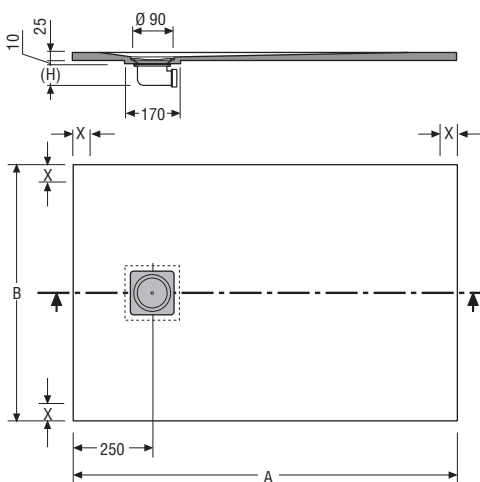
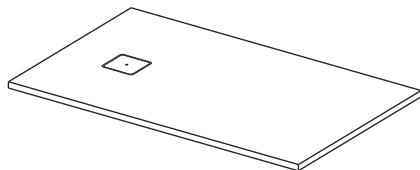

A	B	V	P	A	B	V	P	A	B	V	P
1000	700	0'063	31	1000	750	0'063	33	1000	800	0'063	36
1010 → 1100	700	0'071	35	1010 → 1100	750	0'071	37	1010 → 1100	800	0'071	40
1110 → 1200	700	0'075	38	1110 → 1200	750	0'075	41	1110 → 1200	800	0'075	44
1210 → 1300	700	0'083	41	1210 → 1300	750	0'083	44	1210 → 1300	800	0'083	47
1310 → 1400	700	0'087	44	1310 → 1400	750	0'087	48	1310 → 1400	800	0'087	51
1410 → 1500	700	0'094	47	1410 → 1500	750	0'094	51	1410 → 1500	800	0'094	54
1510 → 1600	700	0'102	51	1510 → 1600	750	0'102	55	1510 → 1600	800	0'102	59
1610 → 1700	700	0'106	54	1610 → 1700	750	0'106	58	1610 → 1700	750	0'106	62

Medidas en mm / Sizes in mm / Mesures en mm/ Medidas em mm

V Volumen de expedición sin palet (m3) | Shipping volume without palet | Volume à l'expédition sans palet | Volume expedição sin palet

P Peso de expedición sin palet (Kg) | Shipping weight without palet | Poids à l'expédition sans palet | Peso de expedição sin palet

X Zona emplazamiento mampara. El espacio mínimo reservado para la mampara es de 30 mm | Glass enclosure zone. The minimum area reserved for the glass enclosure is 30 mm | Zone d'emplacement de la paroi de douche | L'espace minimum réservé à la paroi est de 30 mm | Zona de colocação da divisória. O espaço mínimo necessário à divisória é de 30 mm

(H) Medida en función del desagüe suministrado | Height according to valve supplied | Mesure en fonction du vidage livré | Medida em função da válvula fornecida

PLATO DE DUCHA ZONE RECTANGULAR C / ZONE RECTANGULAR C SHOWER TRAY / RECEVEUR DE DOUCHE ZONE RECTANGULAIRE C / BASE DE CHUVEIRO ZONE RETANGULAR C

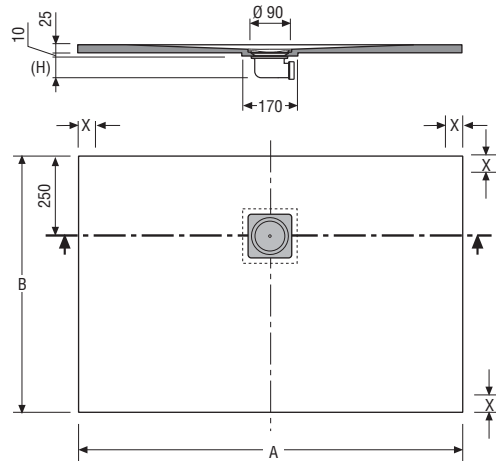
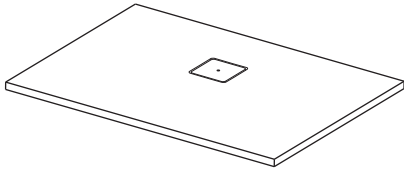

A	B	V	P
1200	900	0'094	49
1210 - 1300	900	0'104	54
1310 - 1400	900	0'109	59
1200	1000	0'094	55
1210 - 1300	1000	0'104	61
1310 - 1400	1000	0'109	66

Medidas en mm / Sizes in mm /
Mesures en mm / Medidas em mm

PLATO DE DUCHA ZONE RECTANGULAR L/R / ZONE RECTANGULAR L/R SHOWER TRAY / RECEVEUR DE DOUCHE ZONE RECTANGULAIRE L/R / BASE DE CHUVEIRO ZONE RETANGULAR L/R

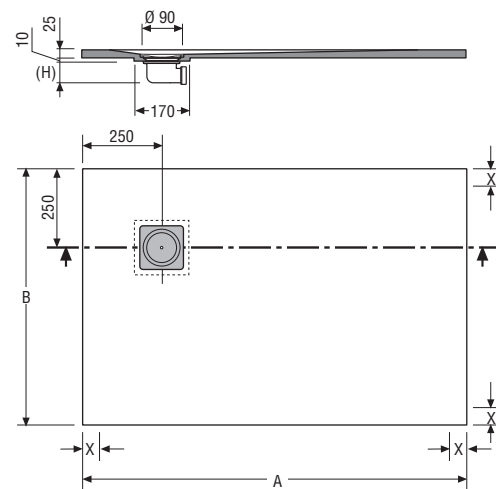
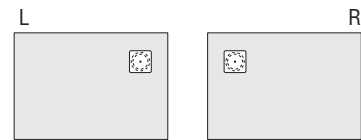
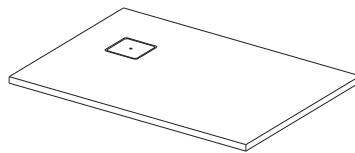
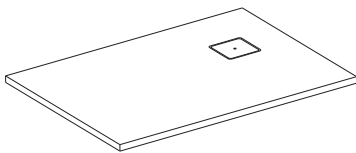

A	B	V	P
1000	900	0'079	41
1010 - 1100	900	0'089	46
1110 - 1200	900	0'094	51
1000	1000	0'079	45
1010 - 1100	1000	0'089	50
1110 - 1200	1000	0'094	55

Medidas en mm / Sizes in mm /
Mesures en mm / Medidas em mm

V Volumen de expedición sin palet (m3) | Shipping volume without palet | Volume à l'expédition sans palet | Volume expedição sin palet
P Peso de expedición sin palet (Kg) | Shipping weight without palet | Poids à l'expédition sans palet | Peso de expedição sin palet
X Zona emplazamiento mampara. El espacio mínimo reservado para la mampara es de 30 mm | Glass enclosure zone. The minimum area reserved for the glass enclosure is 30 mm | Zone d'emplacement de la paroi de douche | L'espace minimum réservé à la paroi est de 30 mm | Zona de colocação da divisória. O espaço mínimo necessário à divisória é de 30 mm
(H) Medida en función del desagüe suministrado | Height according to valve supplied | Mesure en fonction du vidage livré | Medida em função da válvula fornecida

la ducha
PLATOS DE DUCHA

LINE & MOON





LINE
& MOON

LINE Y 135x135 blanco, acabado textura lisa, tapa inox

LINE & MOON

la ducha
PLATOS DE DUCHA





LINE X 90x180 blanco, acabado textura lisa, tapa inox



LINE X 80x180 blanco, acabado textura pizarra, tapa textura pizarra blanco



LINE Y 90x150 blanco, acabado textura lisa, tapa textura lisa



Acabado textura pizarra, color ombra



MOON X 80x180 color ombra, acabado textura pizarra, tapa textura pizarra

LINE & MOON

la ducha
PLATOS DE DUCHA



MOON X 85x160, acabado textura pizarra, tapa inox



MOON X 86x177 cappuccino, acabado textura pizarra, tapa textura pizarra



LINE/MOON X



LINE/MOON Y

ALTURA



30 mm

INSTALACIÓN



Sobre pavimento



Encastrado

TAPAS Y VÁLVULAS

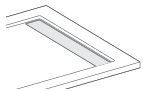

Incluye tapa inox

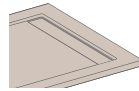

Opcional tapa del mismo material,
acabado y color que el plato

Incluida válvula Ø50 (UNE EN-274)
Posibilidad de instalar con
otras válvulas de Ø50

ACABADO SUPERFICIAL



Acabado textura lisa



Acabado textura pizarra

Tratamiento Antislip Clase 3 (ENV 12633) | C (DIN 51097) | PN24 (XP P05-011). Incluido en Marmek®, opcional en Scene®

MATERIALES Y COLORES

LINE		MOON					
Scene	marmek						
	COLOR BLANCO	COLOR STANDARD				COLOR SPECIAL	
BLANCO	BIANCO	PIETRA	CAPPUCCINO	GRIS	IRON	RAL* / NCS*	
		CREME	TERRA	CEMENT	OMBRA		
		BEIGE	CACAO	STEEL	GRAPHITE		

* Los colores se suministran en gama mate. No se aceptan pedidos de colores brillo o efectos metálicos puesto que se alterarían las características en el producto. Ante cualquier duda, infórmese en nuestro servicio de atención al cliente.

		LINE X				MOON X			
		Scene				marmek			
		COLOR BLANCO		COLOR BIANCO		COLOR STANDARD		COLOR SPECIAL	
		textura lisa	textura pizarra	textura lisa	textura pizarra	textura lisa	textura pizarra	textura lisa	textura pizarra
70	100-110	SLIC 0001	SLIC 0070	SLIC 0134	SLIC 0203	SLIC 0267	SLIC 0336	SLIC 0400	SLIC 0469
	111-120	SLIC 0002	SLIC 0071	SLIC 0135	SLIC 0204	SLIC 0268	SLIC 0337	SLIC 0401	SLIC 0470
	121-130	SLIC 0003	SLIC 0072	SLIC 0136	SLIC 0205	SLIC 0269	SLIC 0338	SLIC 0402	SLIC 0471
	131-140	SLIC 0004	SLIC 0073	SLIC 0137	SLIC 0206	SLIC 0270	SLIC 0339	SLIC 0403	SLIC 0472
	141-150	SLIC 0005	SLIC 0074	SLIC 0138	SLIC 0207	SLIC 0271	SLIC 0340	SLIC 0404	SLIC 0473
	151-160	SLIC 0006	SLIC 0075	SLIC 0139	SLIC 0208	SLIC 0272	SLIC 0341	SLIC 0405	SLIC 0474
	161-170	SLIC 0007	SLIC 0076	SLIC 0140	SLIC 0209	SLIC 0273	SLIC 0342	SLIC 0406	SLIC 0475
	171-180	SLIC 0008	SLIC 0077	SLIC 0141	SLIC 0210	SLIC 0274	SLIC 0343	SLIC 0407	SLIC 0476
	181-190	SLIC 0009	SLIC 0078	SLIC 0142	SLIC 0211	SLIC 0275	SLIC 0344	SLIC 0408	SLIC 0477
	191-200	SLIC 0010	SLIC 0079	SLIC 0143	SLIC 0212	SLIC 0276	SLIC 0345	SLIC 0409	SLIC 0478
71-75	100-110	SLIC 0011	SLIC 0080	SLIC 0144	SLIC 0213	SLIC 0277	SLIC 0346	SLIC 0410	SLIC 0479
	111-120	SLIC 0012	SLIC 0081	SLIC 0145	SLIC 0214	SLIC 0278	SLIC 0347	SLIC 0411	SLIC 0480
	121-130	SLIC 0013	SLIC 0082	SLIC 0146	SLIC 0215	SLIC 0279	SLIC 0348	SLIC 0412	SLIC 0481
	131-140	SLIC 0014	SLIC 0083	SLIC 0147	SLIC 0216	SLIC 0280	SLIC 0349	SLIC 0413	SLIC 0482
	141-150	SLIC 0015	SLIC 0084	SLIC 0148	SLIC 0217	SLIC 0281	SLIC 0350	SLIC 0414	SLIC 0483
	151-160	SLIC 0016	SLIC 0085	SLIC 0149	SLIC 0218	SLIC 0282	SLIC 0351	SLIC 0415	SLIC 0484
	161-170	SLIC 0017	SLIC 0086	SLIC 0150	SLIC 0219	SLIC 0283	SLIC 0352	SLIC 0416	SLIC 0485
	171-180	SLIC 0018	SLIC 0087	SLIC 0151	SLIC 0220	SLIC 0284	SLIC 0353	SLIC 0417	SLIC 0486
	181-190	SLIC 0019	SLIC 0088	SLIC 0152	SLIC 0221	SLIC 0285	SLIC 0354	SLIC 0418	SLIC 0487
	191-200	SLIC 0020	SLIC 0089	SLIC 0153	SLIC 0222	SLIC 0286	SLIC 0355	SLIC 0419	SLIC 0488

		LINE X		MOON X					
		Scene		marmek					
		COLOR BLANCO		COLOR BIANCO		COLOR STANDARD		COLOR SPECIAL	
		textura lisa	textura pizarra	textura lisa	textura pizarra	textura lisa	textura pizarra	textura lisa	textura pizarra
76-80	100-110	SLIC 0021	SLIC 0090	SLIC 0154	SLIC 0223	SLIC 0287	SLIC 0356	SLIC 0420	SLIC 0489
	111-120	SLIC 0022	SLIC 0091	SLIC 0155	SLIC 0224	SLIC 0288	SLIC 0357	SLIC 0421	SLIC 0490
	121-130	SLIC 0023	SLIC 0092	SLIC 0156	SLIC 0225	SLIC 0289	SLIC 0358	SLIC 0422	SLIC 0491
	131-140	SLIC 0024	SLIC 0093	SLIC 0157	SLIC 0226	SLIC 0290	SLIC 0359	SLIC 0423	SLIC 0492
	141-150	SLIC 0025	SLIC 0094	SLIC 0158	SLIC 0227	SLIC 0291	SLIC 0360	SLIC 0424	SLIC 0493
	151-160	SLIC 0026	SLIC 0095	SLIC 0159	SLIC 0228	SLIC 0292	SLIC 0361	SLIC 0425	SLIC 0494
	161-170	SLIC 0027	SLIC 0096	SLIC 0160	SLIC 0229	SLIC 0293	SLIC 0362	SLIC 0426	SLIC 0495
	171-180	SLIC 0028	SLIC 0097	SLIC 0161	SLIC 0230	SLIC 0294	SLIC 0363	SLIC 0427	SLIC 0496
	181-190	SLIC 0029	SLIC 0098	SLIC 0162	SLIC 0231	SLIC 0295	SLIC 0364	SLIC 0428	SLIC 0497
	191-200	SLIC 0030	SLIC 0099	SLIC 0163	SLIC 0232	SLIC 0296	SLIC 0365	SLIC 0429	SLIC 0498
81-90	100-110	SLIC 0031	SLIC 0100	SLIC 0164	SLIC 0233	SLIC 0297	SLIC 0366	SLIC 0430	SLIC 0499
	111-120	SLIC 0032	SLIC 0101	SLIC 0165	SLIC 0234	SLIC 0298	SLIC 0367	SLIC 0431	SLIC 0500
	121-130	SLIC 0033	SLIC 0102	SLIC 0166	SLIC 0235	SLIC 0299	SLIC 0368	SLIC 0432	SLIC 0501
	131-140	SLIC 0034	SLIC 0118	SLIC 0167	SLIC 0236	SLIC 0300	SLIC 0369	SLIC 0433	SLIC 0502
	141-150	SLIC 0035	SLIC 0104	SLIC 0168	SLIC 0237	SLIC 0301	SLIC 0370	SLIC 0434	SLIC 0503
	151-160	SLIC 0036	SLIC 0120	SLIC 0169	SLIC 0238	SLIC 0302	SLIC 0371	SLIC 0435	SLIC 0504
	161-170	SLIC 0037	SLIC 0106	SLIC 0170	SLIC 0239	SLIC 0303	SLIC 0372	SLIC 0436	SLIC 0505
	171-180	SLIC 0038	SLIC 0122	SLIC 0171	SLIC 0240	SLIC 0304	SLIC 0373	SLIC 0437	SLIC 0506
	181-190	SLIC 0039	SLIC 0108	SLIC 0172	SLIC 0241	SLIC 0305	SLIC 0374	SLIC 0438	SLIC 0507
	191-200	SLIC 0040	SLIC 0124	SLIC 0173	SLIC 0242	SLIC 0306	SLIC 0375	SLIC 0439	SLIC 0508

		LINE X				MOON X				
		Scene				marmek				
		COLOR BLANCO		COLOR BIANCO		COLOR STANDARD		COLOR SPECIAL		
		textura lisa	textura pizarra	textura lisa	textura pizarra	textura lisa	textura pizarra	textura lisa	textura pizarra	
Rectangular	91-100	100-110	-	SLIC 0110	-	SLIC 0243	-	SLIC 0376	-	SLIC 0509
		111-120	-	SLIC 0111	-	SLIC 0244	-	SLIC 0377	-	SLIC 0510
		121-130	-	SLIC 0112	-	SLIC 0245	-	SLIC 0378	-	SLIC 0511
		131-140	-	SLIC 0113	-	SLIC 0246	-	SLIC 0379	-	SLIC 0512
Cuadrado	80-90	80-90	SLIC 0041	SLIC 0114	SLIC 0174	SLIC 0247	SLIC 0307	SLIC 0380	SLIC 0440	SLIC 0513
	91-100	91-100	SLIC 0042	SLIC 0115	SLIC 0175	SLIC 0248	SLIC 0308	SLIC 0381	SLIC 0441	SLIC 0514

		LINE Y		MOON Y					
		Scene		marmek					
		COLOR BLANCO		COLOR BIANCO		COLOR STANDARD		COLOR SPECIAL	
		textura lisa	textura pizarra	textura lisa	textura pizarra	textura lisa	textura pizarra	textura lisa	textura pizarra
80	120-130	SLIC 0043	SLIC 0116	SLIC 0176	SLIC 0249	SLIC 0309	SLIC 0382	SLIC 0442	SLIC 0515
	131-140	SLIC 0044	SLIC 0117	SLIC 0177	SLIC 0250	SLIC 0310	SLIC 0383	SLIC 0443	SLIC 0516
	141-150	SLIC 0045	SLIC 0103	SLIC 0178	SLIC 0251	SLIC 0311	SLIC 0384	SLIC 0444	SLIC 0517
	151-160	SLIC 0046	SLIC 0119	SLIC 0179	SLIC 0252	SLIC 0312	SLIC 0385	SLIC 0445	SLIC 0518
	161-170	SLIC 0047	SLIC 0105	SLIC 0180	SLIC 0253	SLIC 0313	SLIC 0386	SLIC 0446	SLIC 0519
	171-180	SLIC 0048	SLIC 0121	SLIC 0181	SLIC 0254	SLIC 0314	SLIC 0387	SLIC 0447	SLIC 0520
81-90	120-130	SLIC 0049	SLIC 0107	SLIC 0182	SLIC 0255	SLIC 0315	SLIC 0388	SLIC 0448	SLIC 0521
	131-140	SLIC 0050	SLIC 0123	SLIC 0183	SLIC 0256	SLIC 0316	SLIC 0389	SLIC 0449	SLIC 0522
	141-150	SLIC 0051	SLIC 0109	SLIC 0184	SLIC 0257	SLIC 0317	SLIC 0390	SLIC 0450	SLIC 0523
	151-160	SLIC 0052	SLIC 0125	SLIC 0185	SLIC 0258	SLIC 0318	SLIC 0391	SLIC 0451	SLIC 0524
	161-170	SLIC 0053	SLIC 0126	SLIC 0186	SLIC 0259	SLIC 0319	SLIC 0392	SLIC 0452	SLIC 0525
	171-180	SLIC 0054	SLIC 0127	SLIC 0187	SLIC 0260	SLIC 0320	SLIC 0393	SLIC 0453	SLIC 0526
91-100	120-130	SLIC 0055	SLIC 0128	SLIC 0188	SLIC 0261	SLIC 0321	SLIC 0394	SLIC 0454	SLIC 0527
	131-140	SLIC 0056	SLIC 0129	SLIC 0189	SLIC 0262	SLIC 0322	SLIC 0395	SLIC 0455	SLIC 0528
	141-150	SLIC 0057	SLIC 0130	SLIC 0190	SLIC 0263	SLIC 0323	SLIC 0396	SLIC 0456	SLIC 0529
	151-160	SLIC 0058	SLIC 0131	SLIC 0191	SLIC 0264	SLIC 0324	SLIC 0397	SLIC 0457	SLIC 0530
	161-170	SLIC 0059	SLIC 0132	SLIC 0192	SLIC 0265	SLIC 0325	SLIC 0398	SLIC 0458	SLIC 0531
	171-180	SLIC 0060	SLIC 0133	SLIC 0193	SLIC 0266	SLIC 0326	SLIC 0399	SLIC 0459	SLIC 0532

Rectangular		LINE Y				MOON Y			
		Scene				marmek			
		COLOR BLANCO		COLOR BIANCO		COLOR STANDARD		COLOR SPECIAL	
		textura lisa	textura pizarra	textura lisa	textura pizarra	textura lisa	textura pizarra	textura lisa	textura pizarra
120-130	120-130	SLIC 0061	-	SLIC 0194	-	SLIC 0327	-	SLIC 0460	-
	131-140	SLIC 0062	-	SLIC 0195	-	SLIC 0328	-	SLIC 0461	-
	141-150	SLIC 0063	-	SLIC 0196	-	SLIC 0329	-	SLIC 0462	-
131-140	120-130	SLIC 0064	-	SLIC 0197	-	SLIC 0330	-	SLIC 0463	-
	131-140	SLIC 0065	-	SLIC 0198	-	SLIC 0331	-	SLIC 0464	-
	141-150	SLIC 0066	-	SLIC 0199	-	SLIC 0332	-	SLIC 0465	-
141-150	120-130	SLIC 0067	-	SLIC 0200	-	SLIC 0333	-	SLIC 0466	-
	131-140	SLIC 0068	-	SLIC 0201	-	SLIC 0334	-	SLIC 0467	-
	141-150	SLIC 0069	-	SLIC 0202	-	SLIC 0335	-	SLIC 0468	-

LINE & MOON X Y X Y

código

ancho x largo

material

color

textura

forma

Scene® (Line)
 Marmek® (Moon)

Scene® (Line)
 blanco

Marmek® (Moon)
 blanco
 standard
 special

liso
 pizarra

rectangular
 cuadrado

↳ TAPA VÁLVULA

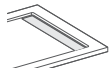

incluido Tapa inox para desagüe

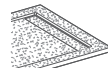

+ Tapa para desagüe
Con el mismo color y textura que el plato

↳ VÁLVULA

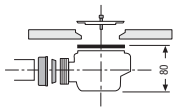

incluido Válvula salida horizontal Viega 50 Domoplex
Según norma EN-274

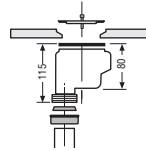

+ Válvula salida vertical Viega 50 Domoplex
Según norma EN-274

↳ TRATAMIENTO ANTISLIP



incluido Tratamiento Antislip Clase 3 ENV 12633 |
C (DIN 51097) | PN24 (XP P05-011), para Marmek®



+ Tratamiento Antislip Clase 3 ENV 12633 |
C (DIN 51097) | PN24 (XP P05-011), para Scene®

↳ CORTE



incluido Cortes longitudinales en ancho y largo cm a cm

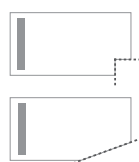

+ Cortes especiales cm a cm
Los pedidos serán confirmados mediante plano técnico



LINE & MOON

la ducha
PLATOS DE DUCHA
información técnica

PLATO DE DUCHA LINE X & MOON X RECTANGULAR / LINE X & MOON X RECTANGULAR SHOWER TRAY / RECEVEUR DE DOUCHE LINE X & MOON X RECTANGULAIRE / BASE DE CHUVEIRO LINE X & MOON X RETANGULAR

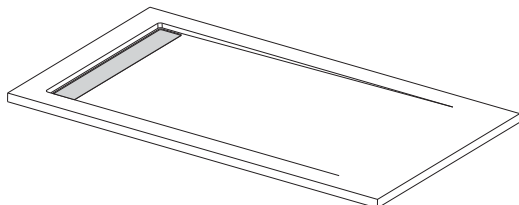

A	B	C	D	E	V	P	A	B	C	D	E	V	P
1000	700	30	660	30	0'063	36	1000	800	80	660	30	0'063	42
1010 → 1100	700	30	660	30	0'071	41	1010 → 1100	800	80	660	30	0'071	47
1110 → 1200	700	30	660	30	0'075	45	1110 → 1200	800	80	660	30	0'075	52
1210 → 1300	700	30	660	30	0'083	48	1210 → 1300	800	80	660	30	0'083	55
1310 → 1400	700	30	660	30	0'087	52	1310 → 1400	800	80	660	30	0'087	60
1410 → 1500	700	30	660	30	0'094	54	1410 → 1500	800	80	660	30	0'094	63
1510 → 1600	700	30	660	30	0'102	59	1510 → 1600	800	80	660	30	0'102	68
1610 → 1700	700	30	660	30	0'106	61	1610 → 1700	800	80	660	30	0'106	71
1710 → 1800	700	30	660	30	0'114	66	1710 → 1800	800	80	660	30	0'114	76
1810 → 1900	700	30	660	35	0'135	78	1810 → 1900	800	80	660	35	0'135	91
1910 → 2000	700	30	660	35	0'139	83	1910 → 2000	800	80	660	35	0'139	96
1000	750	55	660	30	0'063	39	1000	900	80	760	30	0'079	47
1010 → 1100	750	55	660	30	0'071	44	1010 → 1100	900	80	760	30	0'089	53
1110 → 1200	750	55	660	30	0'075	48	1110 → 1200	900	80	760	30	0'094	59
1210 → 1300	750	55	660	30	0'083	51	1210 → 1300	900	80	760	30	0'104	62
1310 → 1400	750	55	660	30	0'087	56	1310 → 1400	900	80	760	30	0'109	68
1410 → 1500	750	55	660	30	0'094	59	1410 → 1500	900	80	760	30	0'119	72
1510 → 1600	750	55	660	30	0'102	64	1510 → 1600	900	80	760	30	0'124	77
1610 → 1700	750	55	660	30	0'106	66	1610 → 1700	900	80	760	30	0'134	81
1710 → 1800	750	55	660	30	0'114	71	1710 → 1800	900	80	760	30	0'139	86
1810 → 1900	750	55	660	35	0'135	84	1810 → 1900	900	80	760	35	0'135	100
1910 → 2000	750	55	660	35	0'139	90	1910 → 2000	900	80	760	35	0'139	106
1000	1000	80	860	30	0'079	52	1010 → 1100	1000	80	860	30	0'089	58
1110 → 1200	1000	80	860	30	0'094	64	1210 → 1300	1000	80	860	30	0'104	68
1310 → 1400	1000	80	860	30	0'109	74	1410 → 1500	1000	80	860	30	0'119	78

Medidas en mm / Sizes in mm /
Mesures en mm / Medidas em mm

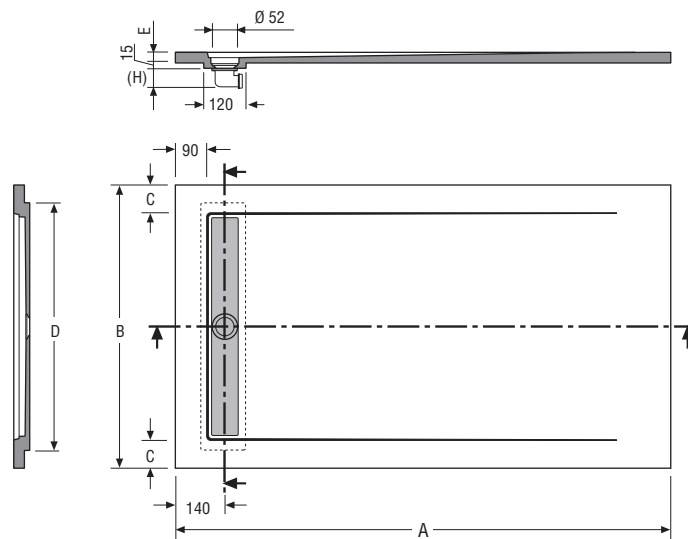

PLATO DE DUCHA LINE X & MOON X CUADRADO / LINE X & MOON X SQUARE SHOWER TRAY / RECEVEUR DE DOUCHE LINE X & MOON X CARRÉ / BASE DE CHUVEIRO LINE X & MOON X QUADRADO

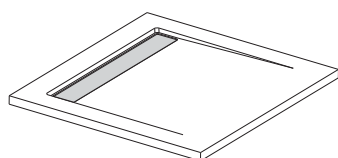

A	B	C	D	E	V	P
800	800	30	760	30	0'079	35
900	900	80	760	30	0'079	44
1000	1000	80	860	30	0'079	53

Medidas en mm / Sizes in mm /
Mesures en mm / Medidas em mm

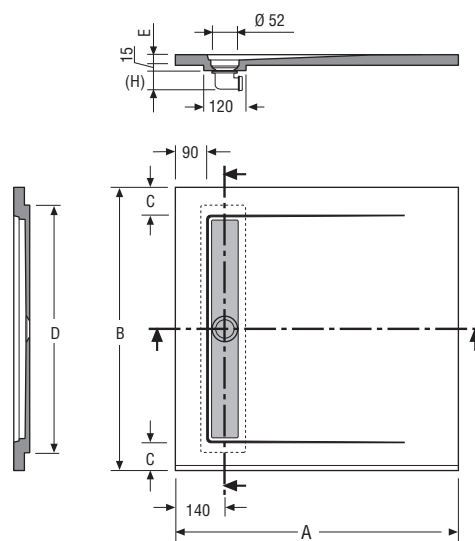

V Volumen de expedición sin palet (m3) | Shipping volume without pallet | Volume à l'expédition sans pallet | Volume expedição sin palet
P Peso de expedición sin palet (Kg) | Shipping weight without pallet | Poids à l'expédition sans pallet | Peso de expedição sin palet

(H) Medida en función del desagüe suministrado | Height according to valve supplied | Mesure en fonction du vidage livré | Medida em função da válvula fornecida

PLATO DE DUCHA LINE Y & MOON Y / LINE Y & MOON Y SHOWER TRAY / RECEVEUR DE DOUCHE LINE Y & MOON Y / BASE DE CHUVEIRO LINE Y & MOON Y

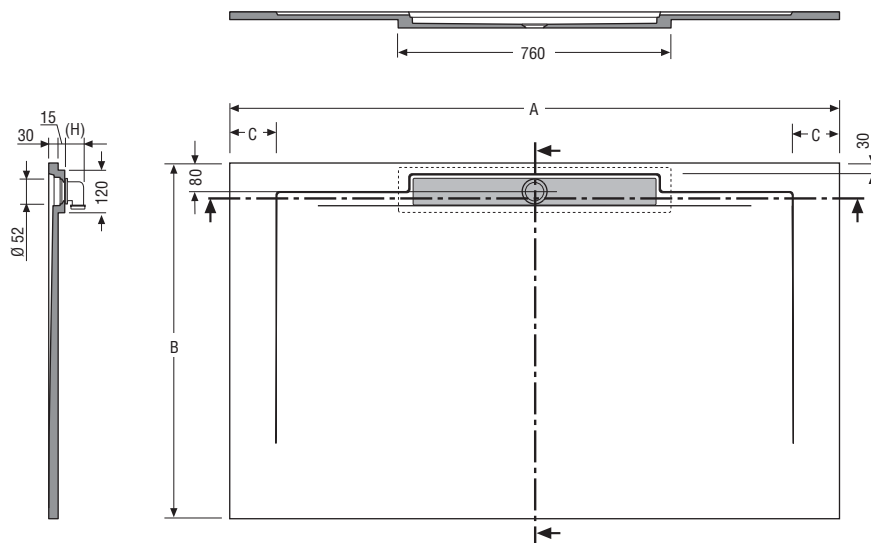
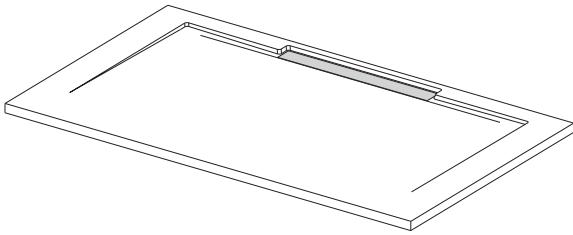

A	B	C	V	P	A	B	C	V	P	A	B	C	V	P
1200	800	30	0'094	49	1200	900	30	0'094	55	1200	1000	30	0'094	62
1210 → 1300	800	35 → 80	0'104	54	1210 → 1300	900	35 → 80	0'104	61	1210 → 1300	1000	35 → 80	0'104	69
1310 → 1400	800	85 → 130	0'109	59	1310 → 1400	900	85 → 130	0'109	67	1310 → 1400	1000	85 → 130	0'109	75
1410 → 1500	800	35 → 80	0'119	62	1410 → 1500	900	35 → 80	0'119	70	1410 → 1500	1000	35 → 80	0'119	79
1510 → 1600	800	85 → 130	0'124	67	1510 → 1600	900	85 → 130	0'124	76	1510 → 1600	1000	85 → 130	0'124	85
1610 → 1700	800	35 → 80	0'134	70	1610 → 1700	900	35 → 80	0'134	80	1610 → 1700	1000	35 → 80	0'134	89
1710 → 1800	800	85 → 130	0'139	75	1710 → 1800	900	85 → 130	0'139	85	1710 → 1800	1000	85 → 130	0'139	95

A	B	C	V	P	A	B	C	V	P	A	B	C	V	P	A	B	C	V	P
1200	1200	30	0'146	91	1200	1300	30	0'157	100	1200	1400	30	0'168	109	1200	1500	30	0'179	118
1210 → 1300	1200	35 → 80	0'156	100	1210 → 1300	1300	35 → 80	0'168	109	1210 → 1300	1400	35 → 80	0'180	119	1210 → 1300	1500	35 → 80	0'192	128
1310 → 1400	1200	85 → 130	0'166	108	1310 → 1400	1300	85 → 130	0'179	119	1310 → 1400	1400	85 → 130	0'192	129	1310 → 1400	1500	85 → 130	0'205	139
1410 → 1500	1200	135 → 180	0'177	117	1410 → 1500	1300	135 → 180	0'190	128	1410 → 1500	1400	135 → 180	0'204	139	1410 → 1500	1500	135 → 180	0'218	150

Medidas en mm / Sizes in mm / Mesures en mm / Medidas em mm

V Volumen de expedición sin palet (m3) | Shipping volume without pallet | Volume à l'expédition sans palet | Volume expedição sin palet
P Peso de expedición sin palet (Kg) | Shipping weight without pallet | Poids à l'expédition sans palet | Peso de expedição sin palet

(H) Medida en función del desagüe suministrado | Height according to valve supplied | Mesure en fonction du vidage livré | Medida em função da válvula fornecida

la ducha
PLATOS DE DUCHA

CUBE & QUADRO



QUADRO 80x180 terra, acabado textura pizarra,
rejilla cuadrada del mismo color que el plato

CUBE & QUADRO

la ducha
PLATOS DE DUCHA



QUADRO 80x140 terra, acabado textura pizarra, rejilla cuadrada inox



CUBE 80x140 blanco, acabado textura pizarra, rejilla cuadrada inox

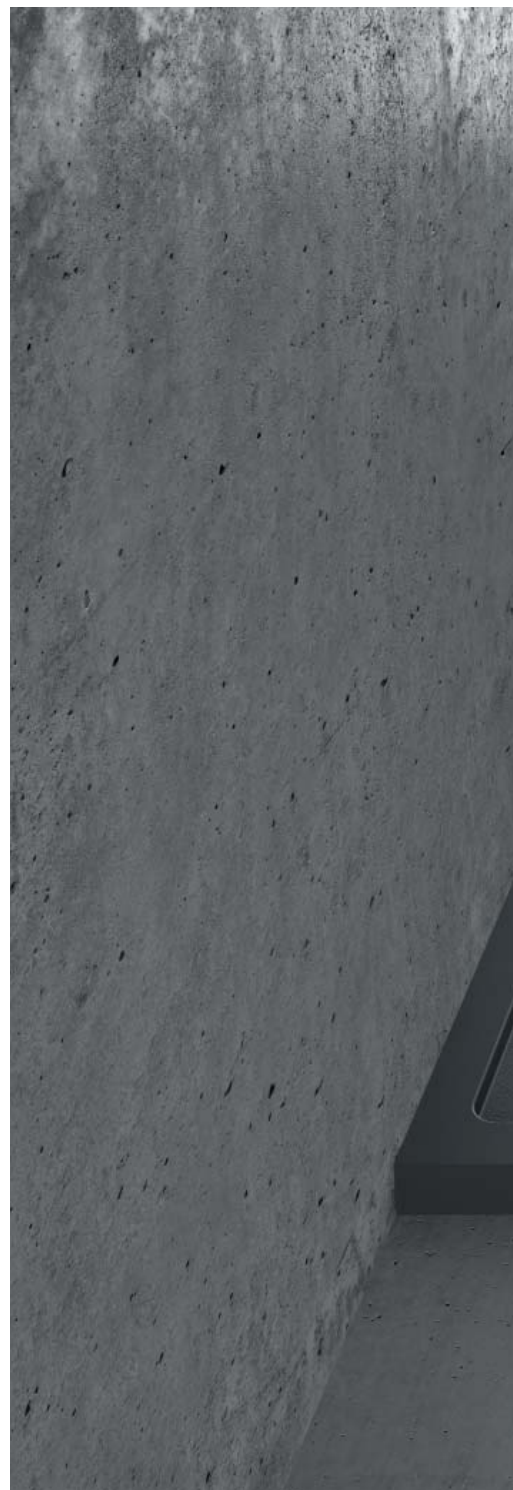



QUADRO 80x140 ombra, acabado textura pizarra, rejilla cuadrada inox

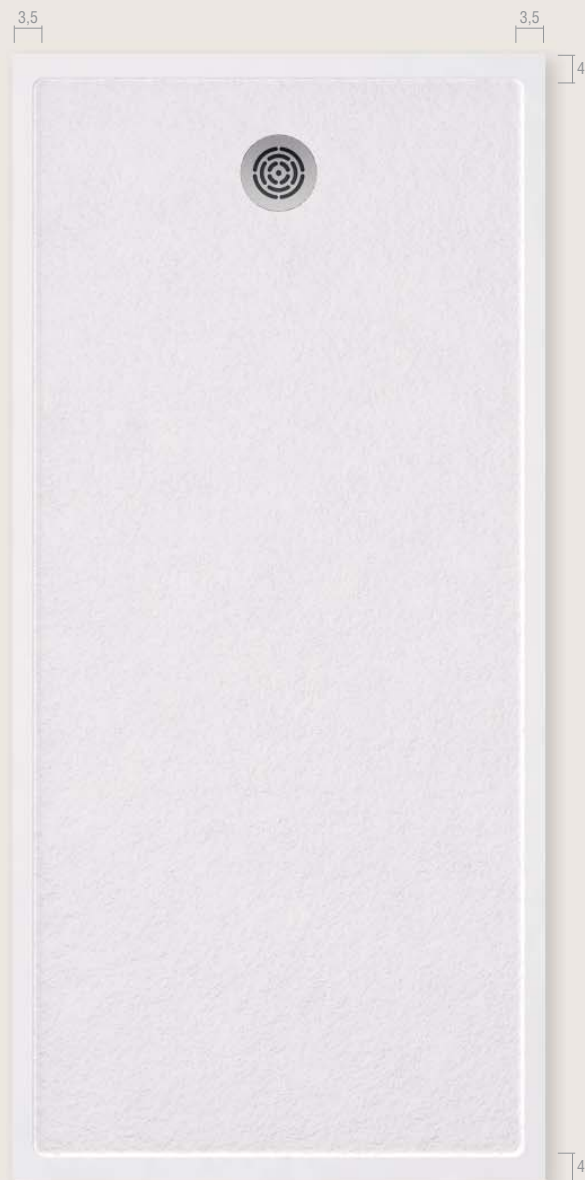

Las dimensiones de pestañas son constantes en los siguientes formatos:

70 x 100	80 x 100	90 x 100
x 110	x 110	x 110
x 120	x 120	x 120
x 130	x 130	x 130
x 140	x 140	x 140
x 150	x 150	x 150
x 160	x 160	x 160
x 170	x 170	x 170
x 180	x 180	x 180
x 190	x 190	x 190

En los restantes formatos las pestañas varían su dimensión para ajustarse a la medida solicitada



ALTURA



INSTALACIÓN



Sobre pavimento



Encastrado

REJILLAS Y VÁLVULAS

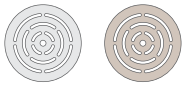

Incluye rejilla redonda inox
Opcional del mismo color que el plato

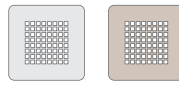

Opcional rejilla cuadrada inox o
del mismo color que el plato

Incluida válvula Ø90 (UNE EN-274)
Posibilidad de instalar con
otras válvulas de Ø90

ACABADO SUPERFICIAL



Acabado textura pizarra

Tratamiento Antislip Clase 3 (ENV 12633) | C (DIN 51097) | PN24 (XP P05-011). Incluido en Marmek®, opcional en Scene®

MATERIALES Y COLORES

CUBE	QUADRO					
Scene	marmek					
	COLOR BLANCO	COLOR STANDARD				COLOR SPECIAL
 BLANCO	 BIANCO	 PIETRA	 CAPPUCCINO	 GRIS	 IRON	 RAL* / NCS*
		 CREME	 TERRA	 CEMENT	 OMBRA	
		 BEIGE	 CACAO	 STEEL	 GRAPHITE	

* Los colores se suministran en gama mate. No se aceptan pedidos de colores brillo o efectos metálicos puesto que se alterarían las características en el producto. Ante cualquier duda, infórmese en nuestro servicio de atención al cliente.

CUBE & QUADRO

la ducha
PLATOS DE DUCHA
tarifa

		CUBE	QUADRO		
		Scene	marmek		
		COLOR BLANCO textura pizarra	COLOR BIANCO textura pizarra	COLOR STANDARD textura pizarra	COLOR SPECIAL textura pizarra
70	100-110	SCUC 0001	SCUC 0051	SCUC 0101	SCUC 0151
	111-120	SCUC 0002	SCUC 0052	SCUC 0102	SCUC 0152
	121-130	SCUC 0003	SCUC 0053	SCUC 0103	SCUC 0153
	131-140	SCUC 0004	SCUC 0054	SCUC 0104	SCUC 0154
	141-150	SCUC 0005	SCUC 0055	SCUC 0105	SCUC 0155
	151-160	SCUC 0006	SCUC 0056	SCUC 0106	SCUC 0156
	161-170	SCUC 0007	SCUC 0057	SCUC 0107	SCUC 0157
	171-180	SCUC 0008	SCUC 0058	SCUC 0108	SCUC 0158
	181-190	SCUC 0009	SCUC 0059	SCUC 0109	SCUC 0159
	191-200	SCUC 0010	SCUC 0060	SCUC 0110	SCUC 0160
71-75	100-110	SCUC 0011	SCUC 0061	SCUC 0111	SCUC 0161
	111-120	SCUC 0012	SCUC 0062	SCUC 0112	SCUC 0162
	121-130	SCUC 0013	SCUC 0063	SCUC 0113	SCUC 0163
	131-140	SCUC 0014	SCUC 0064	SCUC 0114	SCUC 0164
	141-150	SCUC 0015	SCUC 0065	SCUC 0115	SCUC 0165
	151-160	SCUC 0016	SCUC 0066	SCUC 0116	SCUC 0166
	161-170	SCUC 0017	SCUC 0067	SCUC 0117	SCUC 0167
	171-180	SCUC 0018	SCUC 0068	SCUC 0118	SCUC 0168
	181-190	SCUC 0019	SCUC 0069	SCUC 0119	SCUC 0169
	191-200	SCUC 0020	SCUC 0070	SCUC 0120	SCUC 0170

		CUBE	QUADRO		
		Scene	marmek		
		COLOR BLANCO textura pizarra	COLOR BIANCO textura pizarra	COLOR STANDARD textura pizarra	COLOR SPECIAL textura pizarra
80	100-110	SCUC 0021	SCUC 0071	SCUC 0121	SCUC 0171
	111-120	SCUC 0022	SCUC 0072	SCUC 0122	SCUC 0172
	121-130	SCUC 0023	SCUC 0073	SCUC 0123	SCUC 0173
	131-140	SCUC 0024	SCUC 0074	SCUC 0124	SCUC 0174
	141-150	SCUC 0025	SCUC 0075	SCUC 0125	SCUC 0175
	151-160	SCUC 0026	SCUC 0076	SCUC 0126	SCUC 0176
	161-170	SCUC 0027	SCUC 0077	SCUC 0127	SCUC 0177
	171-180	SCUC 0028	SCUC 0078	SCUC 0128	SCUC 0178
	181-190	SCUC 0029	SCUC 0079	SCUC 0129	SCUC 0179
	191-200	SCUC 0030	SCUC 0080	SCUC 0130	SCUC 0180
81-90	100-110	SCUC 0031	SCUC 0081	SCUC 0131	SCUC 0181
	111-120	SCUC 0032	SCUC 0082	SCUC 0132	SCUC 0182
	121-130	SCUC 0033	SCUC 0083	SCUC 0133	SCUC 0183
	131-140	SCUC 0034	SCUC 0084	SCUC 0134	SCUC 0184
	141-150	SCUC 0035	SCUC 0085	SCUC 0135	SCUC 0185
	151-160	SCUC 0036	SCUC 0086	SCUC 0136	SCUC 0186
	161-170	SCUC 0037	SCUC 0087	SCUC 0137	SCUC 0187
	171-180	SCUC 0038	SCUC 0088	SCUC 0138	SCUC 0188
	181-190	SCUC 0039	SCUC 0089	SCUC 0139	SCUC 0189
	191-200	SCUC 0040	SCUC 0090	SCUC 0140	SCUC 0190

		CUBE	QUADRO		
		Scene	marmek		
		COLOR BLANCO textura pizarra	COLOR BIANCO textura pizarra	COLOR STANDARD textura pizarra	COLOR SPECIAL textura pizarra
91-100	100-110	SCUC 0041	SCUC 0091	SCUC 0141	SCUC 0191
	111-120	SCUC 0042	SCUC 0092	SCUC 0142	SCUC 0192
	121-130	SCUC 0043	SCUC 0093	SCUC 0143	SCUC 0193
	131-140	SCUC 0044	SCUC 0094	SCUC 0144	SCUC 0194
	141-150	SCUC 0045	SCUC 0095	SCUC 0145	SCUC 0195
	151-160	SCUC 0046	SCUC 0096	SCUC 0146	SCUC 0196
	161-170	SCUC 0047	SCUC 0097	SCUC 0147	SCUC 0197
	171-180	SCUC 0048	SCUC 0098	SCUC 0148	SCUC 0198
	181-190	SCUC 0049	SCUC 0099	SCUC 0149	SCUC 0199
	191-200	SCUC 0050	SCUC 0100	SCUC 0150	SCUC 0200

CUBE & QUADRO

código

ancho

largo

material

- Scene® (Cube)
- Marmek® (Quadro)

color

- Scene® (Cube)
 - blanco
- Marmek® (Quadro)
 - blanco
 - standard
 - special

textura

- pizarra

forma

- rectangular

REJILLA VÁLVULA



incluido Rejilla redonda inox



+ Rejilla cuadrada inox



+ Rejilla redonda con el mismo color que el plato de ducha



+ Rejilla cuadrada con el mismo color que el plato de ducha

VÁLVULA

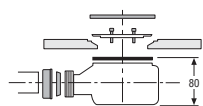

incluido Válvula salida horizontal Viega 90 Tempoplex
Según norma EN-274

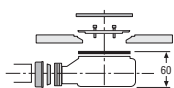

+ Válvula salida horizontal Viega 90 Tempoplex extraplana

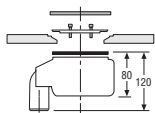

+ Válvula salida vertical Viega 90 Tempoplex
Según norma EN-274

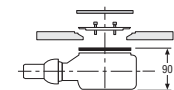

+ Válvula salida horizontal Viega 90 Tempoplex Plus

TRATAMIENTO ANTISLIP



incluido Tratamiento Antislip Clase 3 ENV 12633 |
C (DIN 51097) | PN24 (XP P05-011), para Marmek®



+ Tratamiento Antislip Clase 3 ENV 12633 |
C (DIN 51097) | PN24 (XP P05-011), para Scene®

CORTE



incluido Cortes longitudinales en ancho y largo cm a cm



+ Cortes especiales cm a cm

Los pedidos serán confirmados mediante plano técnico



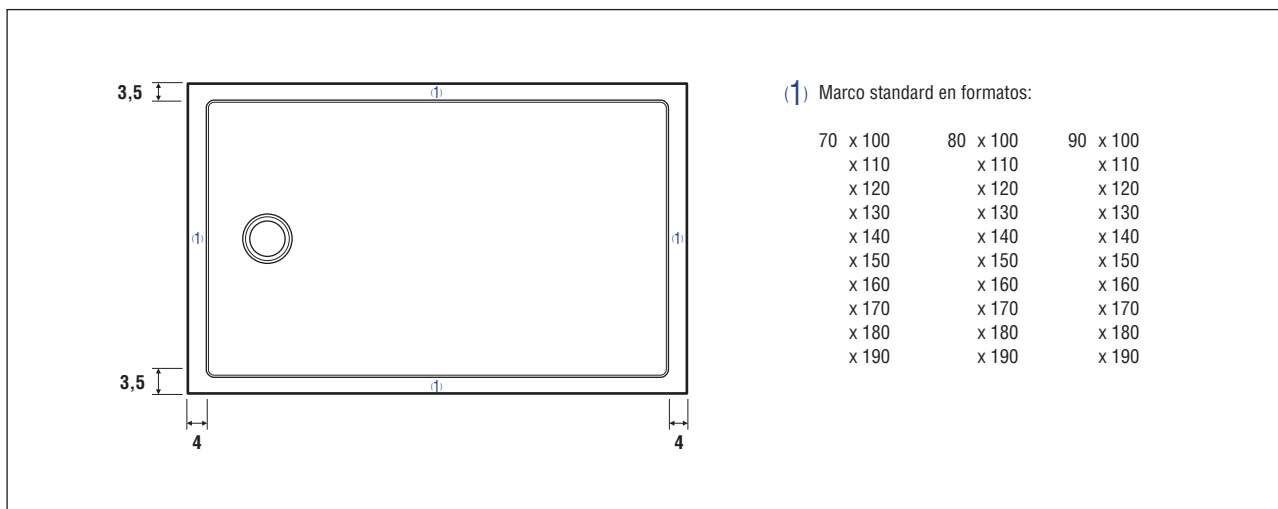

1) Marco standard en formatos:

70 x 100	80 x 100	90 x 100
x 110	x 110	x 110
x 120	x 120	x 120
x 130	x 130	x 130
x 140	x 140	x 140
x 150	x 150	x 150
x 160	x 160	x 160
x 170	x 170	x 170
x 180	x 180	x 180
x 190	x 190	x 190

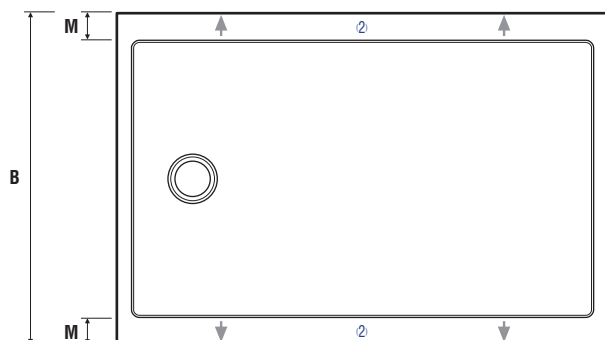

2) Recrece el marco en anchos de:

- 70 → 75
- 80 → 89
- 90 → 100

Medida del marco en cm según ancho del plato

B	M	B	M	B	M	B	M
70	3,5	80	3,5	90	3,5	100	8,5
71	4,0	81	4,0	91	4,0		
72	4,5	82	4,5	92	4,5		
73	5,0	83	5,0	93	5,0		
74	5,5	84	5,5	94	5,5		
75	6,0	85	6,0	95	6,0		
		86	6,5	96	6,5		
		87	7,0	97	7,0		
		88	7,5	98	7,5		
		89	8,0	99	8,0		

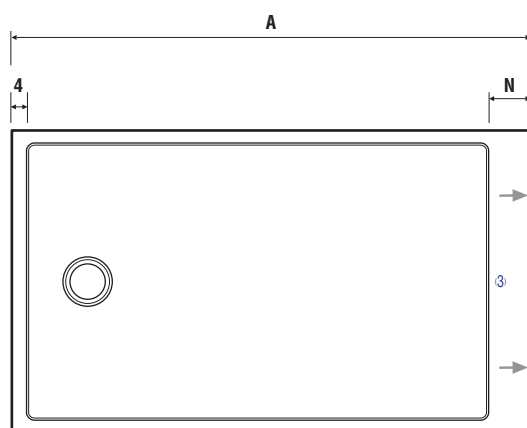

3) Recrece el marco en largos de:

- 100 → 109
- 110 → 119
- 120 → 129
- 130 → 139
- 140 → 149
- 150 → 159
- 160 → 169
- 170 → 179
- 180 → 189
- 190 → 200

Medida del marco en cm según largura del plato

										A	N
100	110	120	130	140	150	160	170	180	190		4
101	111	121	131	141	151	161	171	181	191		5
102	112	122	132	142	152	162	172	182	192		6
103	113	123	133	143	153	163	173	183	193		7
104	114	124	134	144	154	164	174	184	194		8
105	115	125	135	145	155	165	175	185	195		9
106	116	126	136	146	156	166	176	186	196		10
107	117	127	137	147	157	167	177	187	197		11
108	118	128	138	148	158	168	178	188	198		12
109	119	129	139	149	159	169	179	189	199		13
									200		14

N = 4 → 13 Medidas en cm
(incremento de hasta 9 cm más en el lado opuesto del desagüe)

PLATO DE DUCHA CUBE & QUADRO / CUBE & QUADRO SHOWER TRAY / RECEVEUR DE DOUCHE CUBE & QUADRO / BASE DE CHUVEIRO CUBE & QUADRO

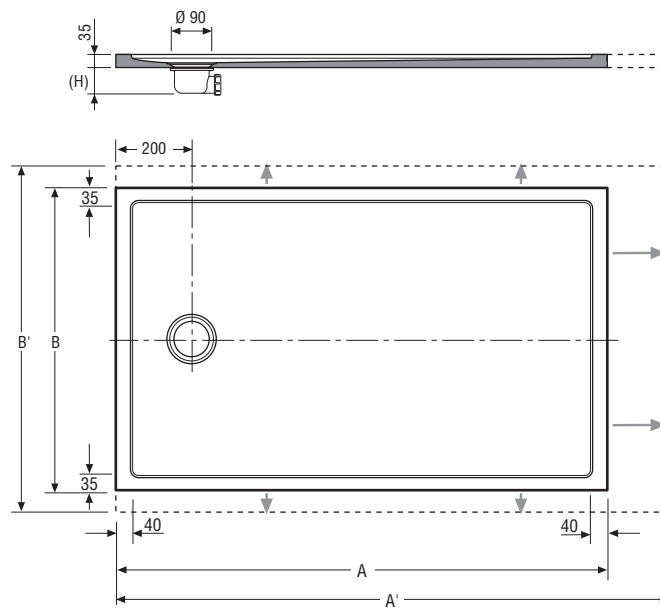
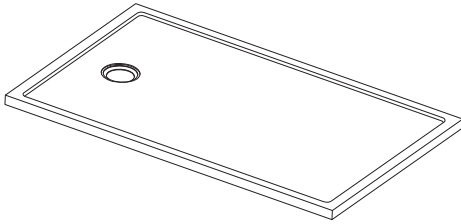

A	A'	B	B'	V	P	V'	P'
1000	1090	700	750	0'063	35	0'071	43
1100	1190	700	750	0'071	38	0'075	47
1200	1290	700	750	0'075	42	0'083	51
1300	1390	700	750	0'083	45	0'087	54
1400	1490	700	750	0'087	48	0'094	58
1500	1590	700	750	0'094	52	0'102	62
1600	1690	700	750	0'102	55	0'106	66
1700	1790	700	750	0'106	62	0'114	73
1800	1890	700	750	0'114	66	0'114	77
1900	2000	700	750	0'118	70	0'114	83

A	A'	B	B'	V	P	V'	P'
1000	1090	800	890	0,063	39	0,089	52
1100	1190	800	890	0,071	43	0,094	57
1200	1290	800	890	0,075	47	0,104	61
1300	1390	800	890	0,083	50	0,109	66
1400	1490	800	890	0,087	54	0,119	70
1500	1590	800	890	0,094	58	0,124	75
1600	1690	800	890	0,102	62	0,134	79
1700	1790	800	890	0,106	70	0,139	88
1800	1890	800	890	0,114	74	0,130	92
1900	2000	800	890	0,118	78	0,139	97

A	A'	B	B'	V	P	V'	P'
1000	1090	900	1000	0'079	44	0'089	58
1100	1190	900	1000	0'089	49	0'094	63
1200	1290	900	1000	0'094	53	0'104	68
1300	1390	900	1000	0'104	57	0'109	73
1400	1490	900	1000	0'109	62	0'119	78
1500	1590	90	1000	0'119	66	0'124	83
1600	1690	900	1000	0'124	70	0'134	88
1700	1790	900	1000	0'139	80	0'139	98
1800	1890	900	1000	0'130	83	0'125	116
1900	2000	900	1000	0'135	88	0'137	124

Medidas en mm / Sizes in mm /
Mesures en mm / Medidas em mm

V Volumen de expedición sin palet (m3) | Shipping volume without palet | Volume à l'expédition sans palet | Volume expedição sin palet
P Peso de expedición sin palet (Kg) | Shipping weight without palet | Poids à l'expédition sans palet | Peso de expedição sin palet

(H) Medida en función del desagüe suministrado | Height according to valve supplied | Mesure en fonction du vidage livré | Medida em função da válvula fornecida

la ducha
PLATOS DE DUCHA

NATURE & NEO





NATURE
& NEO

NATURE 110x210 blanco, acabado textura lisa, rejilla cuadrada inox





NATURE 90x120 blanco, acabado textura pizarra, rejilla redonda inox



NEO 90x190 ombra, acabado textura pizarra, rejilla redonda inox



NEO 90x120 color cacao, acabado textura pizarra, rejilla cuadrada



NEO 90x120 color creme, acabado textura pizarra, rejilla redonda inox



NEO 110x170 cement, acabado textura pizarra, rejilla cuadrada color, con marco en todo el lateral L3 y en medio lateral L4



Rejilla redonda inox



Rejilla redonda color blanco



Rejilla cuadrada inox

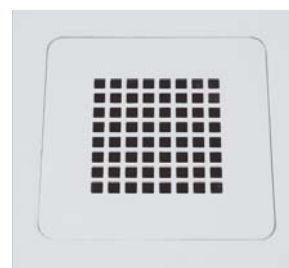

Rejilla cuadrada color blanco

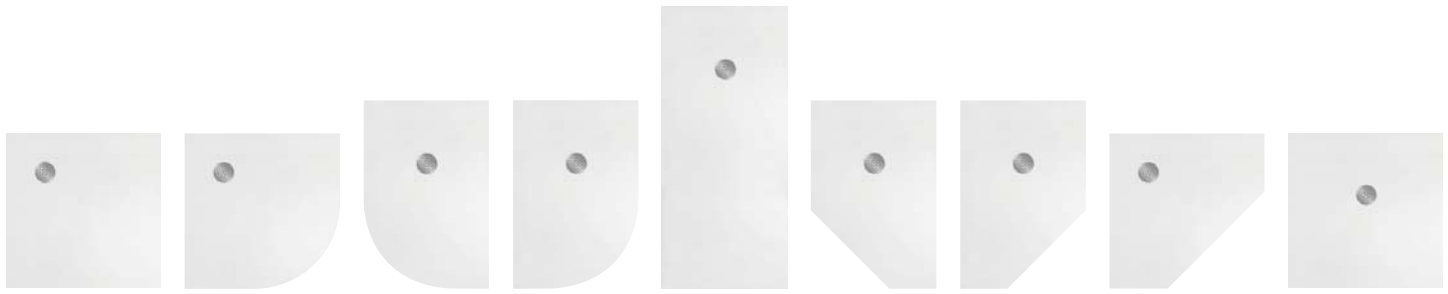

ALTURA

INSTALACIÓN

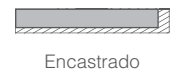
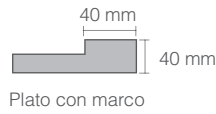

REJILLAS Y VÁLVULAS

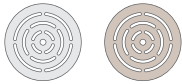

Incluye rejilla redonda inox
Opcional del mismo color que el plato

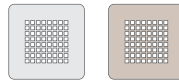

Opcional rejilla cuadrada inox o
del mismo color que el plato

Incluida válvula Ø90 (UNE EN-274)
Posibilidad de instalar con
otras válvulas de Ø90

ACABADO SUPERFICIAL



Acabado textura lisa



Acabado textura pizarra

Tratamiento Antislip Clase 3 (ENV 12633) | C (DIN 51097) | PN24 (XP P05-011). Incluido en Marmek®, opcional en Scene®

MATERIALES Y COLORES

NATURE	NEO					
Scene	marmek					
	COLOR BLANCO	COLOR STANDARD				COLOR SPECIAL
 BLANCO	 BIANCO	 PIETRA	 CAPPUCCINO	 GRIS	 IRON	 RAL* / NCS*
		 CREME	 TERRA	 CEMENT	 OMBRA	
		 BEIGE	 CACAO	 STEEL	 GRAPHITE	

* Los colores se suministran en gama mate. No se aceptan pedidos de colores brillo o efectos metálicos puesto que se alterarían las características en el producto. Ante cualquier duda, infórmese en nuestro servicio de atención al cliente.

		NATURE				NEO			
		Scene				marmek			
		COLOR BLANCO		COLOR BIANCO		COLOR STANDARD		COLOR SPECIAL	
		textura lisa	textura pizarra	textura lisa	textura pizarra	textura lisa	textura pizarra	textura lisa	textura pizarra
70	80-90	SNAC 0001	SNAC 0078	SNAC 0181	SNAC 0258	SNAC 0361	SNAC 0438	SNAC 0541	SNAC 0618
	91-100	SNAC 0002	SNAC 0079	SNAC 0182	SNAC 0259	SNAC 0362	SNAC 0439	SNAC 0542	SNAC 0619
	101-110	SNAC 0003	SNAC 0080	SNAC 0183	SNAC 0260	SNAC 0363	SNAC 0440	SNAC 0543	SNAC 0620
	111-120	SNAC 0004	SNAC 0081	SNAC 0184	SNAC 0261	SNAC 0364	SNAC 0441	SNAC 0544	SNAC 0621
	121-130	SNAC 0005	SNAC 0082	SNAC 0185	SNAC 0262	SNAC 0365	SNAC 0442	SNAC 0545	SNAC 0622
	131-140	SNAC 0006	SNAC 0083	SNAC 0186	SNAC 0263	SNAC 0366	SNAC 0443	SNAC 0546	SNAC 0623
	141-150	SNAC 0007	SNAC 0084	SNAC 0187	SNAC 0264	SNAC 0367	SNAC 0444	SNAC 0547	SNAC 0624
	151-160	SNAC 0008	SNAC 0085	SNAC 0188	SNAC 0265	SNAC 0368	SNAC 0445	SNAC 0548	SNAC 0625
	161-170	SNAC 0009	SNAC 0086	SNAC 0189	SNAC 0266	SNAC 0369	SNAC 0446	SNAC 0549	SNAC 0626
	171-180	SNAC 0010	SNAC 0087	SNAC 0190	SNAC 0267	SNAC 0370	SNAC 0447	SNAC 0550	SNAC 0627
	181-190	SNAC 0011	SNAC 0088	SNAC 0191	SNAC 0268	SNAC 0371	SNAC 0448	SNAC 0551	SNAC 0628
	191-200	SNAC 0012	SNAC 0089	SNAC 0192	SNAC 0269	SNAC 0372	SNAC 0449	SNAC 0552	SNAC 0629
	201-210	SNAC 0013	SNAC 0090	SNAC 0193	SNAC 0270	SNAC 0373	SNAC 0450	SNAC 0553	SNAC 0630
71-75	80-90	SNAC 0014	SNAC 0091	SNAC 0194	SNAC 0271	SNAC 0374	SNAC 0451	SNAC 0554	SNAC 0631
	91-100	SNAC 0015	SNAC 0092	SNAC 0195	SNAC 0272	SNAC 0375	SNAC 0452	SNAC 0555	SNAC 0632
	101-110	SNAC 0016	SNAC 0093	SNAC 0196	SNAC 0273	SNAC 0376	SNAC 0453	SNAC 0556	SNAC 0633
	111-120	SNAC 0017	SNAC 0094	SNAC 0197	SNAC 0274	SNAC 0377	SNAC 0454	SNAC 0557	SNAC 0634
	121-130	SNAC 0018	SNAC 0095	SNAC 0198	SNAC 0275	SNAC 0378	SNAC 0455	SNAC 0558	SNAC 0635
	131-140	SNAC 0019	SNAC 0096	SNAC 0199	SNAC 0276	SNAC 0379	SNAC 0456	SNAC 0559	SNAC 0636
	141-150	SNAC 0020	SNAC 0097	SNAC 0200	SNAC 0277	SNAC 0380	SNAC 0457	SNAC 0560	SNAC 0637
	151-160	SNAC 0021	SNAC 0098	SNAC 0201	SNAC 0278	SNAC 0381	SNAC 0458	SNAC 0561	SNAC 0638
	161-170	SNAC 0022	SNAC 0099	SNAC 0202	SNAC 0279	SNAC 0382	SNAC 0459	SNAC 0562	SNAC 0639
	171-180	SNAC 0023	SNAC 0100	SNAC 0203	SNAC 0280	SNAC 0383	SNAC 0460	SNAC 0563	SNAC 0640
	181-190	SNAC 0024	SNAC 0101	SNAC 0204	SNAC 0281	SNAC 0384	SNAC 0461	SNAC 0564	SNAC 0641
	191-200	SNAC 0025	SNAC 0102	SNAC 0205	SNAC 0282	SNAC 0385	SNAC 0462	SNAC 0565	SNAC 0642
	201-210	SNAC 0026	SNAC 0103	SNAC 0206	SNAC 0283	SNAC 0386	SNAC 0463	SNAC 0566	SNAC 0643

		NATURE		NEO					
		Scene		marmek					
		COLOR BLANCO		COLOR BIANCO		COLOR STANDARD		COLOR SPECIAL	
		textura lisa	textura pizarra	textura lisa	textura pizarra	textura lisa	textura pizarra	textura lisa	textura pizarra
76-80	80-90	SNAC 0027	SNAC 0104	SNAC 0207	SNAC 0284	SNAC 0387	SNAC 0464	SNAC 0567	SNAC 0644
	91-100	SNAC 0028	SNAC 0105	SNAC 0208	SNAC 0285	SNAC 0388	SNAC 0465	SNAC 0568	SNAC 0645
	101-110	SNAC 0029	SNAC 0106	SNAC 0209	SNAC 0286	SNAC 0389	SNAC 0466	SNAC 0569	SNAC 0646
	111-120	SNAC 0030	SNAC 0107	SNAC 0210	SNAC 0287	SNAC 0390	SNAC 0467	SNAC 0570	SNAC 0647
	121-130	SNAC 0031	SNAC 0108	SNAC 0211	SNAC 0288	SNAC 0391	SNAC 0468	SNAC 0571	SNAC 0648
	131-140	SNAC 0032	SNAC 0109	SNAC 0212	SNAC 0289	SNAC 0392	SNAC 0469	SNAC 0572	SNAC 0649
	141-150	SNAC 0033	SNAC 0110	SNAC 0213	SNAC 0290	SNAC 0393	SNAC 0470	SNAC 0573	SNAC 0650
	151-160	SNAC 0034	SNAC 0111	SNAC 0214	SNAC 0291	SNAC 0394	SNAC 0471	SNAC 0574	SNAC 0651
	161-170	SNAC 0035	SNAC 0112	SNAC 0215	SNAC 0292	SNAC 0395	SNAC 0472	SNAC 0575	SNAC 0652
	171-180	SNAC 0036	SNAC 0113	SNAC 0216	SNAC 0293	SNAC 0396	SNAC 0473	SNAC 0576	SNAC 0653
	181-190	SNAC 0037	SNAC 0114	SNAC 0217	SNAC 0294	SNAC 0397	SNAC 0474	SNAC 0577	SNAC 0654
	191-200	SNAC 0038	SNAC 0115	SNAC 0218	SNAC 0295	SNAC 0398	SNAC 0475	SNAC 0578	SNAC 0655
201-210	SNAC 0039	SNAC 0116	SNAC 0219	SNAC 0296	SNAC 0399	SNAC 0476	SNAC 0579	SNAC 0656	
81-90	80-90	SNAC 0040	SNAC 0117	SNAC 0220	SNAC 0297	SNAC 0400	SNAC 0477	SNAC 0580	SNAC 0657
	91-100	SNAC 0041	SNAC 0118	SNAC 0221	SNAC 0298	SNAC 0401	SNAC 0478	SNAC 0581	SNAC 0658
	101-110	SNAC 0042	SNAC 0119	SNAC 0222	SNAC 0299	SNAC 0402	SNAC 0479	SNAC 0582	SNAC 0659
	111-120	SNAC 0043	SNAC 0120	SNAC 0223	SNAC 0300	SNAC 0403	SNAC 0480	SNAC 0583	SNAC 0660
	121-130	SNAC 0044	SNAC 0121	SNAC 0224	SNAC 0301	SNAC 0404	SNAC 0481	SNAC 0584	SNAC 0661
	131-140	SNAC 0045	SNAC 0122	SNAC 0225	SNAC 0302	SNAC 0405	SNAC 0482	SNAC 0585	SNAC 0662
	141-150	SNAC 0046	SNAC 0123	SNAC 0226	SNAC 0303	SNAC 0406	SNAC 0483	SNAC 0586	SNAC 0663
	151-160	SNAC 0047	SNAC 0124	SNAC 0227	SNAC 0304	SNAC 0407	SNAC 0484	SNAC 0587	SNAC 0664
	161-170	SNAC 0048	SNAC 0125	SNAC 0228	SNAC 0305	SNAC 0408	SNAC 0485	SNAC 0588	SNAC 0665
	171-180	SNAC 0049	SNAC 0126	SNAC 0229	SNAC 0306	SNAC 0409	SNAC 0486	SNAC 0589	SNAC 0666
	181-190	SNAC 0050	SNAC 0127	SNAC 0230	SNAC 0307	SNAC 0410	SNAC 0487	SNAC 0590	SNAC 0667
	191-200	SNAC 0051	SNAC 0128	SNAC 0231	SNAC 0308	SNAC 0411	SNAC 0488	SNAC 0591	SNAC 0668
201-210	SNAC 0052	SNAC 0129	SNAC 0232	SNAC 0309	SNAC 0412	SNAC 0489	SNAC 0592	SNAC 0669	

NATURE & NEO

















la ducha
PLATOS DE DUCHA
tarifa

		NATURE				NEO			
		Scene				marmek			
		COLOR BLANCO		COLOR BIANCO		COLOR STANDARD		COLOR SPECIAL	
		textura lisa	textura pizarra	textura lisa	textura pizarra	textura lisa	textura pizarra	textura lisa	textura pizarra
91-100	100-110	SNAC 0053	SNAC 0130	SNAC 0233	SNAC 0310	SNAC 0413	SNAC 0490	SNAC 0593	SNAC 0670
	111-120	SNAC 0054	SNAC 0131	SNAC 0234	SNAC 0311	SNAC 0414	SNAC 0491	SNAC 0594	SNAC 0671
	121-130	SNAC 0055	SNAC 0132	SNAC 0235	SNAC 0312	SNAC 0415	SNAC 0492	SNAC 0595	SNAC 0672
	131-140	SNAC 0056	SNAC 0133	SNAC 0236	SNAC 0313	SNAC 0416	SNAC 0493	SNAC 0596	SNAC 0673
	141-150	SNAC 0057	SNAC 0134	SNAC 0237	SNAC 0314	SNAC 0417	SNAC 0494	SNAC 0597	SNAC 0674
	151-160	SNAC 0058	SNAC 0135	SNAC 0238	SNAC 0315	SNAC 0418	SNAC 0495	SNAC 0598	SNAC 0675
	161-170	SNAC 0059	SNAC 0136	SNAC 0239	SNAC 0316	SNAC 0419	SNAC 0496	SNAC 0599	SNAC 0676
	171-180	SNAC 0060	SNAC 0137	SNAC 0240	SNAC 0317	SNAC 0420	SNAC 0497	SNAC 0600	SNAC 0677
	181-190	SNAC 0061	SNAC 0138	SNAC 0241	SNAC 0318	SNAC 0421	SNAC 0498	SNAC 0601	SNAC 0678
	191-200	SNAC 0062	SNAC 0139	SNAC 0242	SNAC 0319	SNAC 0422	SNAC 0499	SNAC 0602	SNAC 0679
	201-210	SNAC 0063	SNAC 0140	SNAC 0243	SNAC 0320	SNAC 0423	SNAC 0500	SNAC 0603	SNAC 0680
101-110	100-110	SNAC 0064	SNAC 0141	SNAC 0244	SNAC 0321	SNAC 0424	SNAC 0501	SNAC 0604	SNAC 0681
	111-120	SNAC 0065	SNAC 0142	SNAC 0245	SNAC 0322	SNAC 0425	SNAC 0502	SNAC 0605	SNAC 0682
	121-130	SNAC 0066	SNAC 0143	SNAC 0246	SNAC 0323	SNAC 0426	SNAC 0503	SNAC 0606	SNAC 0683
	131-140	SNAC 0067	SNAC 0144	SNAC 0247	SNAC 0324	SNAC 0427	SNAC 0504	SNAC 0607	SNAC 0684
	141-150	SNAC 0068	SNAC 0145	SNAC 0248	SNAC 0325	SNAC 0428	SNAC 0505	SNAC 0608	SNAC 0685
	151-160	SNAC 0069	SNAC 0146	SNAC 0249	SNAC 0326	SNAC 0429	SNAC 0506	SNAC 0609	SNAC 0686
	161-170	SNAC 0070	SNAC 0147	SNAC 0250	SNAC 0327	SNAC 0430	SNAC 0507	SNAC 0610	SNAC 0687
	171-180	SNAC 0721	SNAC 0148	SNAC 0725	SNAC 0328	SNAC 0729	SNAC 0508	SNAC 0733	SNAC 0688
	181-190	SNAC 0722	SNAC 0149	SNAC 0726	SNAC 0329	SNAC 0730	SNAC 0509	SNAC 0734	SNAC 0689
	191-200	SNAC 0723	SNAC 0150	SNAC 0727	SNAC 0330	SNAC 0731	SNAC 0510	SNAC 0735	SNAC 0690
	201-210	SNAC 0724	SNAC 0151	SNAC 0728	SNAC 0331	SNAC 0732	SNAC 0511	SNAC 0736	SNAC 0691

		NATURE		NEO					
		Scene		marmek					
		COLOR BLANCO		COLOR BIANCO		COLOR STANDARD		COLOR SPECIAL	
		textura lisa	textura pizarra	textura lisa	textura pizarra	textura lisa	textura pizarra	textura lisa	textura pizarra
Rectangular	111-120	120-130	- SNAC 0152	- SNAC 0332	- SNAC 0512	- SNAC 0692	- SNAC 0512	- SNAC 0692	- SNAC 0692
	131-140	- SNAC 0153	- SNAC 0333	- SNAC 0513	- SNAC 0693	- SNAC 0513	- SNAC 0693	- SNAC 0693	- SNAC 0693
	141-150	- SNAC 0154	- SNAC 0334	- SNAC 0514	- SNAC 0694	- SNAC 0514	- SNAC 0694	- SNAC 0694	- SNAC 0694
	151-160	- SNAC 0155	- SNAC 0335	- SNAC 0515	- SNAC 0695	- SNAC 0515	- SNAC 0695	- SNAC 0695	- SNAC 0695
	161-170	- SNAC 0156	- SNAC 0336	- SNAC 0516	- SNAC 0696	- SNAC 0516	- SNAC 0696	- SNAC 0696	- SNAC 0696
	171-180	- SNAC 0157	- SNAC 0337	- SNAC 0517	- SNAC 0697	- SNAC 0517	- SNAC 0697	- SNAC 0697	- SNAC 0697
Cuadrado	121-130	120-130	- SNAC 0158	- SNAC 0338	- SNAC 0518	- SNAC 0698	- SNAC 0518	- SNAC 0698	- SNAC 0698
	131-140	- SNAC 0159	- SNAC 0339	- SNAC 0519	- SNAC 0699	- SNAC 0519	- SNAC 0699	- SNAC 0699	- SNAC 0699
	141-150	- SNAC 0160	- SNAC 0340	- SNAC 0520	- SNAC 0700	- SNAC 0520	- SNAC 0700	- SNAC 0700	- SNAC 0700
	151-160	- SNAC 0161	- SNAC 0341	- SNAC 0521	- SNAC 0701	- SNAC 0521	- SNAC 0701	- SNAC 0701	- SNAC 0701
	161-170	- SNAC 0162	- SNAC 0342	- SNAC 0522	- SNAC 0702	- SNAC 0522	- SNAC 0702	- SNAC 0702	- SNAC 0702
	171-180	- 1.009 SNAC 0163	- SNAC 0343	- SNAC 0523	- SNAC 0703	- SNAC 0523	- SNAC 0703	- SNAC 0703	- SNAC 0703
80-100	131-140	120-130	- SNAC 0164	- SNAC 0344	- SNAC 0524	- SNAC 0704	- SNAC 0524	- SNAC 0704	- SNAC 0704
	131-140	- SNAC 0165	- SNAC 0345	- SNAC 0525	- SNAC 0705	- SNAC 0525	- SNAC 0705	- SNAC 0705	- SNAC 0705
80-100	80-90	SNAC 0071	SNAC 0166	SNAC 0251	SNAC 0346	SNAC 0431	SNAC 0526	SNAC 0611	SNAC 0706
	91-100	SNAC 0072	SNAC 0167	SNAC 0252	SNAC 0347	SNAC 0432	SNAC 0527	SNAC 0612	SNAC 0707

NATURE & NEO

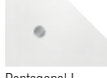
la ducha
PLATOS DE DUCHA
tarifa

		NATURE		NEO					
		Scene		marmek					
		COLOR BLANCO		COLOR BIANCO		COLOR STANDARD		COLOR SPECIAL	
		textura lisa	textura pizarra	textura lisa	textura pizarra	textura lisa	textura pizarra	textura lisa	textura pizarra
	Angular								
									
80	80	SNAC 0073	SNAC 0168	SNAC 0253	SNAC 0348	SNAC 0433	SNAC 0528	SNAC 0613	SNAC 0708
90	90	SNAC 0074	SNAC 0169	SNAC 0254	SNAC 0349	SNAC 0434	SNAC 0529	SNAC 0614	SNAC 0709
100	100	SNAC 0075	SNAC 0170	SNAC 0255	SNAC 0350	SNAC 0435	SNAC 0530	SNAC 0615	SNAC 0710
	Angular R								
									
80	120	-	SNAC 0171	-	SNAC 0351	-	SNAC 0531	-	SNAC 0711
90	120	-	SNAC 0172	-	SNAC 0352	-	SNAC 0532	-	SNAC 0712
	Angular L								
									
80	120	-	SNAC 0173	-	SNAC 0353	-	SNAC 0533	-	SNAC 0713
90	120	-	SNAC 0174	-	SNAC 0354	-	SNAC 0534	-	SNAC 0714
	Pentagonal								
									
90	90	SNAC 0076	SNAC 0175	SNAC 0256	SNAC 0355	SNAC 0436	SNAC 0535	SNAC 0616	SNAC 0715
100	100	SNAC 0077	SNAC 0176	SNAC 0257	SNAC 0356	SNAC 0437	SNAC 0536	SNAC 0617	SNAC 0716
	Pentagonal R								
									
80	120	-	SNAC 0177	-	SNAC 0357	-	SNAC 0537	-	SNAC 0717
90	120	-	SNAC 0178	-	SNAC 0358	-	SNAC 0538	-	SNAC 0718
	Pentagonal L								
									
80	120	-	SNAC 0179	-	SNAC 0359	-	SNAC 0539	-	SNAC 0719
90	120	-	SNAC 0180	-	SNAC 0360	-	SNAC 0540	-	SNAC 0720

NATURE & NEO

código

ancho

largo

material

- Scene (Nature)
- Marmek (Neo)

color

- Scene (Nature)
 - blanco
- Marmek (Neo)
 - blanco
 - standard
 - special

textura

- liso
- pizarra

forma

- rectangular
- cuadrado
- angular
- pentagonal

REJILLA VÁLVULA



incluido Rejilla redonda



+ Rejilla cuadrada



+ Rejilla redonda con el mismo color que el plato de ducha



+ Rejilla cuadrada con el mismo color que el plato de ducha

VÁLVULA

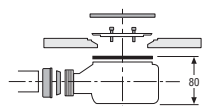

incluido Válvula salida horizontal Viega 90 Tempoplex
Según norma EN-274

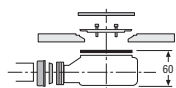

+ Válvula salida horizontal Viega 90 Tempoplex extraplana

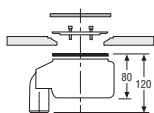

+ Válvula salida vertical Viega 90 Tempoplex
Según norma EN-274

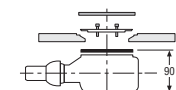

+ Válvula salida horizontal Viega 90 Tempoplex Plus

TRATAMIENTO ANTISLIP



incluido Tratamiento Antislip Clase 3 ENV 12633 | C (DIN 51097) | PN24 (XP P05-011), para Marmek®



+ Tratamiento Antislip Clase 3 ENV 12633 | C (DIN 51097) | PN24 (XP P05-011), para Scene®

CORTE



incluido Cortes longitudinales en ancho y largo cm a cm



+ Cortes especiales cm a cm

Los pedidos serán confirmados mediante plano técnico



MARCO

Marco liso sobre lateral L1/L2/L3/L4 a indicar. Precio por cm lineal

Para platos rectangulares y cuadrados.

Indicar los lados completos donde instalar el marco (únicamente en lados rectos)

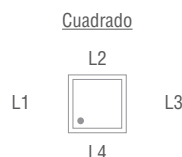
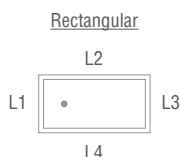

Otras configuraciones

Marcos especiales y/o parciales

Los pedidos serán confirmados mediante plano técnico



NATURE & NEO

la ducha
PLATOS DE DUCHA
información técnica

PLATO DE DUCHA NATURE & NEO RECTANGULAR / NATURE & NEO RECTANGULAR SHOWER TRAY / RECEVEUR DE DOUCHE NATURE & NEO RECTANGULAIRE / BASE DE CHUVEIRO NATURE & NEO RETANGULAR

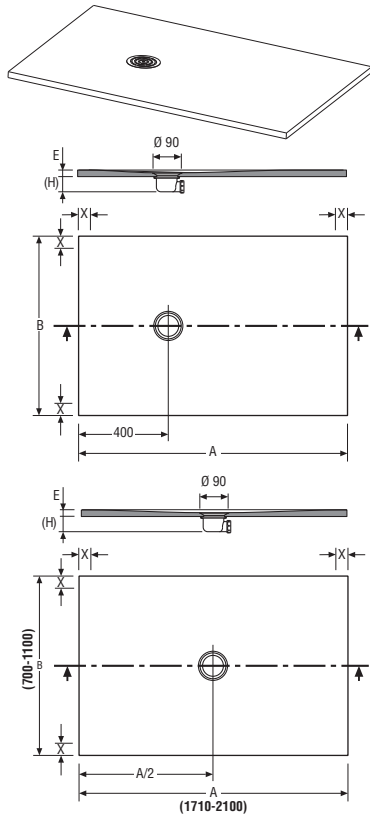

A	B	E	V	P	A	B	E	V	P	A	B	E	V	P	A	B	E	V	P				
800	700	30	0,047	30	800	750	30	0,047	32	800	800	30	0,047	34	800	900	30	0,047	38				
810	→ 900	700	30	0,047	33	810	→ 900	750	30	0,047	36	810	→ 900	800	30	0,047	39	810	→ 900	900	30	0,047	43
910	→ 1000	700	30	0,047	37	910	→ 1000	750	30	0,047	40	910	→ 1000	800	30	0,047	43	910	→ 1000	900	30	0,047	48
1010	→ 1100	700	30	0,056	41	1010	→ 1100	750	30	0,056	44	1010	→ 1100	800	30	0,056	47	1010	→ 1100	900	30	0,056	52
1110	→ 1200	700	30	0,056	45	1110	→ 1200	750	30	0,056	48	1110	→ 1200	800	30	0,056	53	1110	→ 1200	900	30	0,056	57
1210	→ 1300	700	30	0,065	48	1210	→ 1300	750	30	0,065	52	1210	→ 1300	800	30	0,065	53	1210	→ 1300	900	30	0,065	62
1310	→ 1400	700	30	0,065	52	1310	→ 1400	750	30	0,065	56	1310	→ 1400	800	30	0,065	60	1310	→ 1400	900	30	0,065	67
1410	→ 1500	700	30	0,079	55	1410	→ 1500	750	30	0,079	59	1410	→ 1500	800	30	0,079	64	1410	→ 1500	900	30	0,079	71
1510	→ 1600	700	30	0,079	59	1510	→ 1600	750	30	0,079	64	1510	→ 1600	800	30	0,079	68	1510	→ 1600	900	30	0,079	76
1610	→ 1700	700	30	0,079	63	1610	→ 1700	750	30	0,079	68	1610	→ 1700	800	30	0,079	73	1610	→ 1700	900	30	0,079	86
1710	→ 1800	700	30	0,088	66	1710	→ 1800	750	30	0,088	71	1710	→ 1800	800	30	0,088	76	1710	→ 1800	900	30	0,088	84
1810	→ 1900	700	30	0,088	70	1810	→ 1900	750	30	0,088	75	1810	→ 1900	800	30	0,088	81	1810	→ 1900	900	30	0,088	90
1910	→ 2000	700	30	0,098	73	1910	→ 2000	750	30	0,098	79	1910	→ 2000	800	30	0,098	84	1910	→ 2000	900	30	0,098	94
2010	→ 2100	700	30	0,098	77	2010	→ 2100	750	30	0,098	83	2010	→ 2100	800	30	0,098	89	2010	→ 2100	900	30	0,098	99
1000	→ 1100	1000	30	0,068	57	1000	→ 1100	1100	30	0,068	64	1200	→ 1300	1200	30	0,083	87	1200	→ 1300	1300	30	0,090	96
1110	→ 1200	1000	30	0,068	63	1110	→ 1200	1100	30	0,068	70	1310	→ 1400	1200	30	0,089	94	1310	→ 1400	1300	30	0,096	104
1210	→ 1300	1000	30	0,074	68	1210	→ 1300	1100	30	0,074	75	1410	→ 1500	1200	30	0,095	101	1410	→ 1500	1300	30	0,103	109
1310	→ 1400	1000	30	0,080	74	1310	→ 1400	1100	30	0,080	82	1510	→ 1600	1200	30	0,102	108	1510	→ 1600	1300	30	0,110	119
1410	→ 1500	1000	30	0,085	77	1410	→ 1500	1100	30	0,085	85	1610	→ 1700	1200	30	0,108	114	1610	→ 1700	1300	30	0,117	124
1510	→ 1600	1000	30	0,091	83	1510	→ 1600	1100	30	0,091	92	1710	→ 1800	1200	30	0,114	121	1710	→ 1800	1300	30	0,123	135
1610	→ 1700	1000	30	0,096	89	1610	→ 1700	1100	30	0,096	99	1200	→ 1300	1400	30	0,096	104	1310	→ 1400	1400	30	0,104	114
1710	→ 1800	1000	30	0,099	92	1710	→ 1800	1100	30	0,108	102												
1810	→ 1900	1000	30	0,104	98	1810	→ 1900	1100	30	0,114	109												
1910	→ 2000	1000	30	0,109	102	1910	→ 2000	1100	30	0,119	114												
2010	→ 2100	1000	30	0,114	108	2010	→ 2100	1100	30	0,125	120												

Medidas en mm / Sizes in mm / Mesures en mm / Medidas em mm

PLATO DE DUCHA NATURE & NEO PENTAGONAL / NATURE & NEO PENTAGONAL SHOWER TRAY / RECEVEUR DE DOUCHE NATURE & NEO PENTAGONAL / BASE DE CHUVEIRO NATURE & NEO PENTAGONAL

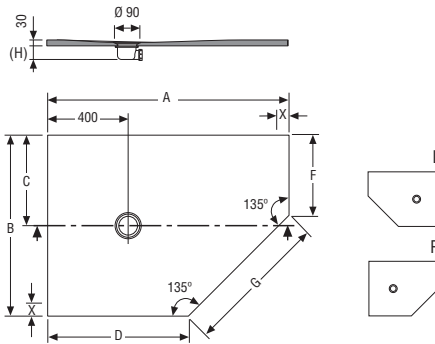
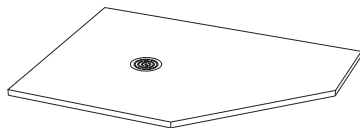

A	B	C	D	G	F	V	P
1200	800	400	700	710	300	0,056	42
1200	900	450	700	710	400	0,056	48

Medidas en mm / Sizes in mm / Mesures en mm / Medidas em mm

PLATO DE DUCHA NATURE & NEO ANGULAR / NATURE & NEO ANGULAR SHOWER TRAY / RECEVEUR DE DOUCHE NATURE & NEO D'ANGLE / BASE DE CHUVEIRO NATURE & NEO ANGULAR

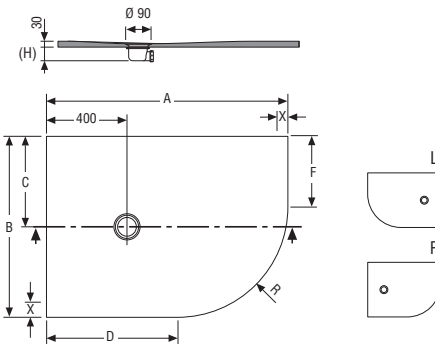
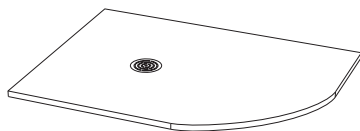

A	B	C	D	F	R	V	P
1200	800	400	650	250	550	0,056	42
1200	900	450	650	350	550	0,056	48

Medidas en mm / Sizes in mm / Mesures en mm / Medidas em mm

V Volumen de expedición sin palet (m3) | Shipping volume without palet | Volume à l'expédition sans palet | Volume expedição sin palet
P Peso de expedición sin palet (Kg) | Shipping weight without palet | Poids à l'expédition sans palet | Peso de expedição sin palet
X Zona emplazamiento mampara. El espacio mínimo reservado para la mampara es de 30 mm | Glass enclosure zone. The minimum area reserved for the glass enclosure is 30 mm | Zone d'emplacement de la paroi de douche | L'espacement minimum réservé à la paroi est de 30 mm | Zona de colocação da divisória. O espaço mínimo necessário à divisória é de 30 mm
(H) Medida en función del desagüe suministrado | Height according to valve supplied | Mesure en fonction du vidage livré | Medida em função da válvula fornecida

PLATO DE DUCHA NATURE & NEO CUADRADO / NATURE & NEO SQUARE SHOWER TRAY / RECEVEUR DE DOUCHE NATURE & NEO CARRÉ / BASE DE CHUVEIRO NATURE & NEO QUADRADO

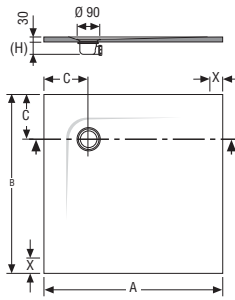
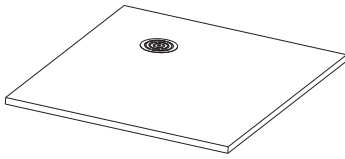

A	B	C	V	P
800	800	150	0,047	36
900	900	200	0,047	44
1000	1000	250	0,068	54

Medidas en mm / Sizes in mm
Mesures en mm / Medidas em mm

PLATO DE DUCHA NATURE & NEO PENTAGONAL / NATURE & NEO PENTAGONAL SHOWER TRAY / RECEVEUR DE DOUCHE NATURE & NEO PENTAGONAL / BASE DE CHUVEIRO NATURE & NEO PENTAGONAL

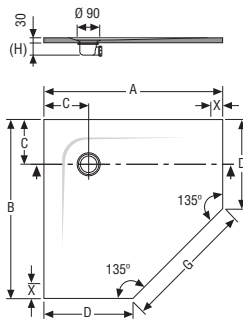
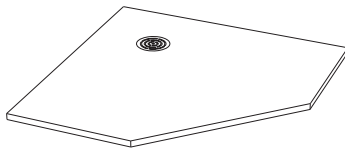

A	B	C	D	G	V	P
900	900	170	400	710	0,047	35
1000	1000	250	500	710	0,068	45

Medidas en mm / Sizes in mm
Mesures en mm / Medidas em mm

PLATO DE DUCHA NATURE & NEO ANGULAR / NATURE & NEO ANGULAR SHOWER TRAY / RECEVEUR DE DOUCHE NATURE & NEO D'ANGLE / BASE DE CHUVEIRO NATURE & NEO ANGULAR

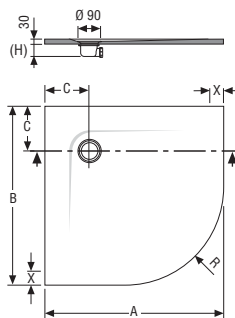
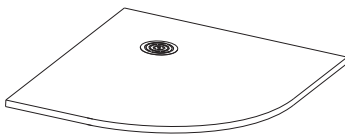

A	B	C	R	V	P
800	800	150	550	0,047	31
900	900	200	550	0,047	39
1000	1000	250	550	0,068	50

Medidas en mm / Sizes in mm
Mesures en mm / Medidas em mm

- V** Volumen de expedición sin palet (m3) | Shipping volume without pallet | Volume à l'expédition sans palet | Volume expedição sin palet
P Peso de expedición sin palet (Kg) | Shipping weight without pallet | Poids à l'expédition sans palet | Peso de expedição sin palet
X Zona emplazamiento mampara. El espacio mínimo reservado para la mampara es de 30 mm | Glass enclosure zone. The minimum area reserved for the glass enclosure is 30 mm | Zona de colocação da divisória. O espaço mínimo necessário à divisória é de 30 mm
H Medida en función del desagüe suministrado | Height according to valve supplied | Mesure en fonction du vidage livré | Medida em função da válvula fornecida

| la ducha
| PLATOS DE DUCHA

ONE





ONE

ONE varios formatos y colores, acabado textura pizarra, rejilla cuadrada color

ONE

la ducha
PLATOS DE DUCHA





ONE varios formatos y colores, acabado textura pizarra, rejilla cuadrada color

ONE

la ducha
PLATOS DE DUCHA

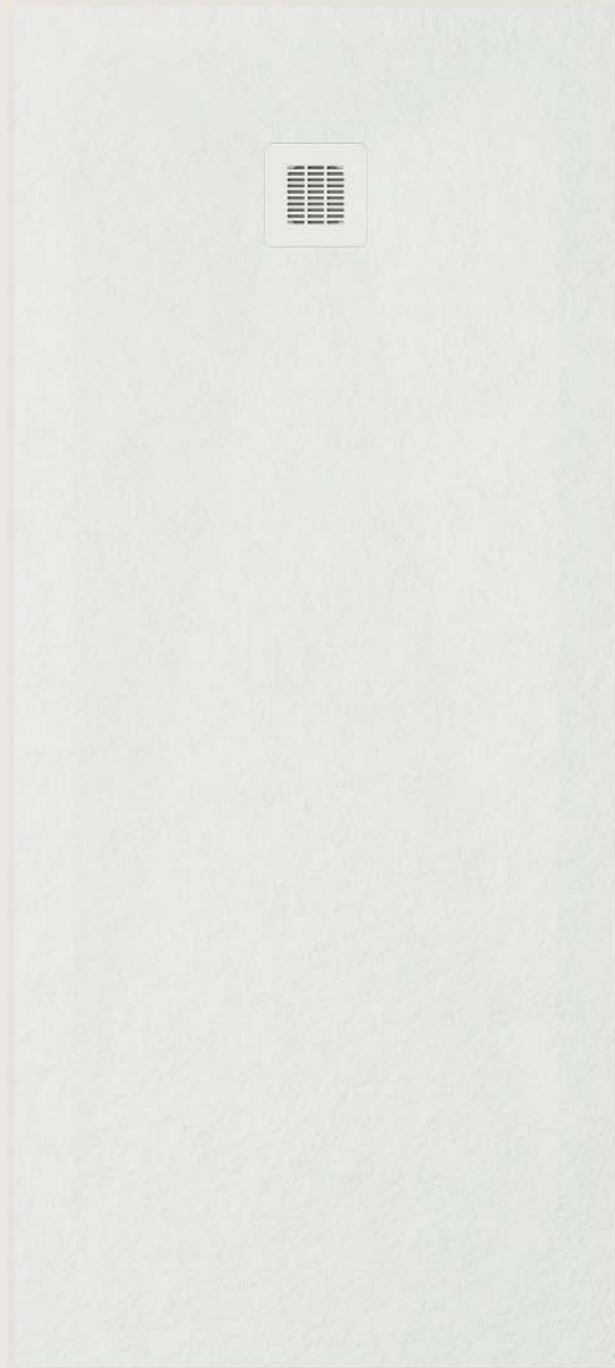

ONE 80x180 bianco, acabado textura pizarra, rejilla cuadrada inox

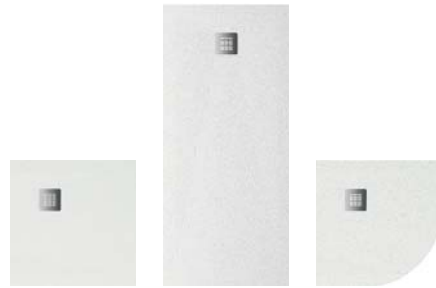

ALTURA



30 mm

INSTALACIÓN



Sobre pavimento



Encastrado

REJILLAS Y VÁLVULAS



Incluye rejilla cuadrada inox



Opcional rejilla cuadrada del mismo color que el plato

Incluida válvula Ø90 (UNE EN-274)
Posibilidad de instalar con otras válvulas de Ø90

ACABADO SUPERFICIAL



Acabado textura pizarra antideslizante

MATERIALES Y COLORES

gelcoat

COLOR STANDARD



BIANCO



BEIGE



CAPPUCINO



CEMENT

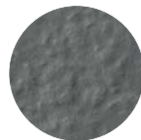

IRON



GRAPHITE



Rectangular



		ONE					
		gelcoat					
		COLOR BIANCO	COLOR BEIGE	COLOR CAPPUCCINO	COLOR CEMENT	COLOR IRON	COLOR GRAPHITE
		textura pizarra	textura pizarra	textura pizarra	textura pizarra	textura pizarra	textura pizarra
70	90	SONC 0397	SONC 0398	SONC 0399	SONC 0400	SONC 0401	SONC 0402
	100	SONC 0001	SONC 0067	SONC 0133	SONC 0199	SONC 0265	SONC 0331
	110	SONC 0002	SONC 0068	SONC 0134	SONC 0200	SONC 0266	SONC 0332
	120	SONC 0003	SONC 0069	SONC 0135	SONC 0201	SONC 0267	SONC 0333
	130	SONC 0004	SONC 0070	SONC 0136	SONC 0202	SONC 0268	SONC 0334
	140	SONC 0005	SONC 0071	SONC 0137	SONC 0203	SONC 0269	SONC 0335
	150	SONC 0006	SONC 0072	SONC 0138	SONC 0204	SONC 0270	SONC 0336
	160	SONC 0007	SONC 0073	SONC 0139	SONC 0205	SONC 0271	SONC 0337
	170	SONC 0008	SONC 0074	SONC 0140	SONC 0206	SONC 0272	SONC 0338
	180	SONC 0009	SONC 0075	SONC 0141	SONC 0207	SONC 0273	SONC 0339
	190	SONC 0010	SONC 0076	SONC 0142	SONC 0208	SONC 0274	SONC 0340
	200	SONC 0011	SONC 0077	SONC 0143	SONC 0209	SONC 0275	SONC 0341
75	90	SONC 0403	SONC 0404	SONC 0405	SONC 0406	SONC 0407	SONC 0408
	100	SONC 0012	SONC 0078	SONC 0144	SONC 0210	SONC 0276	SONC 0342
	110	SONC 0013	SONC 0079	SONC 0145	SONC 0211	SONC 0277	SONC 0343
	120	SONC 0014	SONC 0080	SONC 0146	SONC 0212	SONC 0278	SONC 0344
	130	SONC 0015	SONC 0081	SONC 0147	SONC 0213	SONC 0279	SONC 0345
	140	SONC 0016	SONC 0082	SONC 0148	SONC 0214	SONC 0280	SONC 0346
	150	SONC 0017	SONC 0083	SONC 0149	SONC 0215	SONC 0281	SONC 0347
	160	SONC 0018	SONC 0084	SONC 0150	SONC 0216	SONC 0282	SONC 0348
	170	SONC 0019	SONC 0085	SONC 0151	SONC 0217	SONC 0283	SONC 0349
	180	SONC 0020	SONC 0086	SONC 0152	SONC 0218	SONC 0284	SONC 0350
	190	SONC 0021	SONC 0087	SONC 0153	SONC 0219	SONC 0285	SONC 0351
	200	SONC 0022	SONC 0088	SONC 0154	SONC 0220	SONC 0286	SONC 0352

		ONE					
		gelcoat					
		COLOR BIANCO	COLOR BEIGE	COLOR CAPPUCCINO	COLOR CEMENT	COLOR IRON	COLOR GRAPHITE
		textura pizarra	textura pizarra	textura pizarra	textura pizarra	textura pizarra	textura pizarra
80	90	SONC 0409	SONC 0410	SONC 0411	SONC 0412	SONC 0413	SONC 0414
	100	SONC 0023	SONC 0089	SONC 0155	SONC 0221	SONC 0287	SONC 0353
	110	SONC 0024	SONC 0090	SONC 0156	SONC 0222	SONC 0288	SONC 0354
	120	SONC 0025	SONC 0091	SONC 0157	SONC 0223	SONC 0289	SONC 0355
	130	SONC 0026	SONC 0092	SONC 0158	SONC 0224	SONC 0290	SONC 0356
	140	SONC 0027	SONC 0093	SONC 0159	SONC 0225	SONC 0291	SONC 0357
	150	SONC 0028	SONC 0094	SONC 0160	SONC 0226	SONC 0292	SONC 0358
	160	SONC 0029	SONC 0095	SONC 0161	SONC 0227	SONC 0293	SONC 0359
	170	SONC 0030	SONC 0096	SONC 0162	SONC 0228	SONC 0294	SONC 0360
	180	SONC 0031	SONC 0097	SONC 0163	SONC 0229	SONC 0295	SONC 0361
	190	SONC 0032	SONC 0098	SONC 0164	SONC 0230	SONC 0296	SONC 0362
	200	SONC 0033	SONC 0099	SONC 0165	SONC 0231	SONC 0297	SONC 0363
90	90	SONC 0034	SONC 0100	SONC 0166	SONC 0232	SONC 0298	SONC 0364
	100	SONC 0035	SONC 0101	SONC 0167	SONC 0233	SONC 0299	SONC 0365
	110	SONC 0036	SONC 0102	SONC 0168	SONC 0234	SONC 0300	SONC 0366
	120	SONC 0037	SONC 0103	SONC 0169	SONC 0235	SONC 0301	SONC 0367
	130	SONC 0038	SONC 0104	SONC 0170	SONC 0236	SONC 0302	SONC 0368
	140	SONC 0039	SONC 0105	SONC 0171	SONC 0237	SONC 0303	SONC 0369
	150	SONC 0040	SONC 0106	SONC 0172	SONC 0238	SONC 0304	SONC 0370
	160	SONC 0041	SONC 0107	SONC 0173	SONC 0239	SONC 0305	SONC 0371
	170	SONC 0042	SONC 0108	SONC 0174	SONC 0240	SONC 0306	SONC 0372
	180	SONC 0043	SONC 0109	SONC 0175	SONC 0241	SONC 0307	SONC 0373
	190	SONC 0044	SONC 0110	SONC 0176	SONC 0242	SONC 0308	SONC 0374
	200	SONC 0045	SONC 0111	SONC 0177	SONC 0243	SONC 0309	SONC 0375



Rectangular



		ONE					
		gelcoat					
		COLOR BIANCO	COLOR BEIGE	COLOR CAPPUCCINO	COLOR CEMENT	COLOR IRON	COLOR GRAPHITE
		textura pizarra	textura pizarra	textura pizarra	textura pizarra	textura pizarra	textura pizarra
100	100	SONC 0046	SONC 0112	SONC 0178	SONC 0244	SONC 0310	SONC 0376
	110	SONC 0047	SONC 0113	SONC 0179	SONC 0245	SONC 0311	SONC 0377
	120	SONC 0048	SONC 0114	SONC 0180	SONC 0246	SONC 0312	SONC 0378
	130	SONC 0049	SONC 0115	SONC 0181	SONC 0247	SONC 0313	SONC 0379
	140	SONC 0050	SONC 0116	SONC 0182	SONC 0248	SONC 0314	SONC 0380
	150	SONC 0051	SONC 0117	SONC 0183	SONC 0249	SONC 0315	SONC 0381
	160	SONC 0052	SONC 0118	SONC 0184	SONC 0250	SONC 0316	SONC 0382
	170	SONC 0053	SONC 0119	SONC 0185	SONC 0251	SONC 0317	SONC 0383
	180	SONC 0054	SONC 0120	SONC 0186	SONC 0252	SONC 0318	SONC 0384
	190	SONC 0055	SONC 0121	SONC 0187	SONC 0253	SONC 0319	SONC 0385
	200	SONC 0056	SONC 0122	SONC 0188	SONC 0254	SONC 0320	SONC 0386
110	110	SONC 0057	SONC 0123	SONC 0189	SONC 0255	SONC 0321	SONC 0387
	120	SONC 0058	SONC 0124	SONC 0190	SONC 0256	SONC 0322	SONC 0388
	130	SONC 0059	SONC 0125	SONC 0191	SONC 0257	SONC 0323	SONC 0389
	140	SONC 0060	SONC 0126	SONC 0192	SONC 0258	SONC 0324	SONC 0390
	150	SONC 0061	SONC 0127	SONC 0193	SONC 0259	SONC 0325	SONC 0391
	160	SONC 0062	SONC 0128	SONC 0194	SONC 0260	SONC 0326	SONC 0392
	170	SONC 0063	SONC 0129	SONC 0195	SONC 0261	SONC 0327	SONC 0393
	180	SONC 0064	SONC 0130	SONC 0196	SONC 0262	SONC 0328	SONC 0394
	190	SONC 0065	SONC 0131	SONC 0197	SONC 0263	SONC 0329	SONC 0395
	200	SONC 0066	SONC 0132	SONC 0198	SONC 0264	SONC 0330	SONC 0396

OPCIONES DEL PRODUCTO E INFORMACIÓN TÉCNICA IMPORTANTE



la ducha
PLATOS DE DUCHA
tarifa

ONE

		ONE					
		gelcoat					
		COLOR BIANCO	COLOR BEIGE	COLOR CAPPUCCINO	COLOR CEMENT	COLOR IRON	COLOR GRAPHITE
		textura pizarra					
Cuadrado	80	SONC 0415	SONC 0416	SONC 0417	SONC 0418	SONC 0419	SONC 0420
	90	SONC 0421	SONC 0422	SONC 0423	SONC 0424	SONC 0425	SONC 0426
Angular	80	SONC 0427	SONC 0428	SONC 0429	SONC 0430	SONC 0431	SONC 0432
	90	SONC 0433	SONC 0434	SONC 0435	SONC 0436	SONC 0437	SONC 0438

ONE x material color textura forma

REJILLA VÁLVULA

 **incluido** Rejilla cuadrada inox  + Rejilla cuadrada color

VÁLVULA

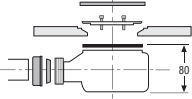
 **incluido** Válvula salida horizontal Viega 90 Tempoplex
Según norma EN-274

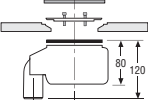
 + Válvula salida vertical Viega 90 Tempoplex
Según norma EN-274

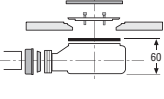
 + Válvula salida horizontal Viega 90 Tempoplex extraplana

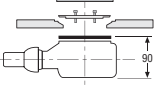
 + Válvula salida horizontal Viega 90 Tempoplex Plus

* Los accesorios o complementos de producto que no sean solicitados con el producto principal serán tratados como repuestos o complementos, según su tarifa y con recargo por transporte. Información de repuestos y complementos en páginas de 146 a 149. Para otras opciones asesórese contactando con el servicio de Atención al Cliente.



ONE, rejilla cuadrada inox

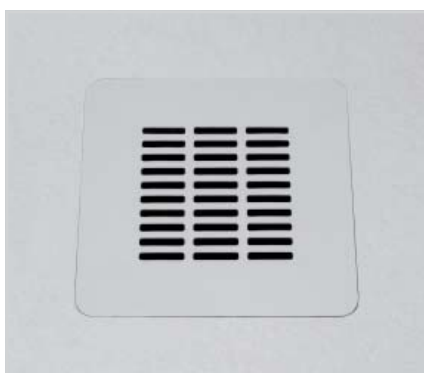

ONE, rejilla cuadrada blanca



ONE, rejilla cuadrada beige

PLATO DE DUCHA ONE RECTANGULAR / ONE RECTANGULAR SHOWER TRAY / RECEVEUR DE DOUCHE ONE RECTANGULAIRE / BASE DE CHUVEIRO ONE RETANGULAR

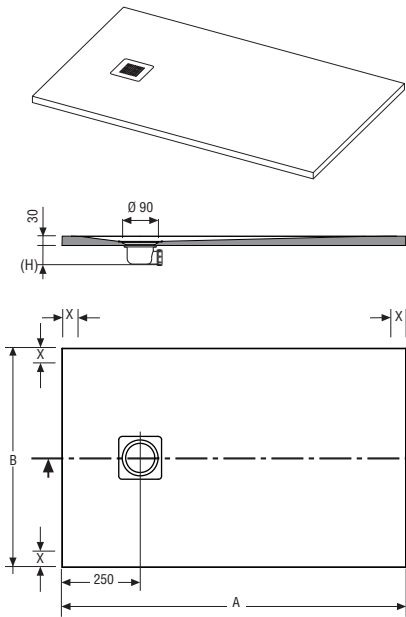

A	B	V	P
900	700	0,047	36
1000	700	0,047	40
1100	700	0,056	44
1200	700	0,056	48
1300	700	0,065	52
1400	700	0,065	56
1500	700	0,079	60
1600	700	0,079	64
1700	700	0,079	67
1800	700	0,088	72

A	B	V	P
900	750	0,047	39
1000	750	0,047	42
1100	750	0,056	47
1200	750	0,056	51
1300	750	0,065	55
1400	750	0,065	59
1500	750	0,079	64
1600	750	0,079	68
1700	750	0,079	72
1800	750	0,088	76

A	B	V	P
900	800	0,047	41
1000	800	0,047	45
1100	800	0,056	50
1200	800	0,056	54
1300	800	0,065	59
1400	800	0,065	63
1500	800	0,079	68
1600	800	0,079	72
1700	800	0,079	76
1800	800	0,088	81

A	B	V	P
900	900	0,047	46
1000	900	0,047	50
1100	900	0,056	55
1200	900	0,056	60
1300	900	0,065	65
1400	900	0,065	70
1500	900	0,079	75
1600	900	0,079	80
1700	900	0,079	85
1800	900	0,088	90

A	B	V	P
1000	1000	0,068	57
1100	1000	0,068	62
1200	1000	0,068	67
1300	1000	0,074	72
1400	1000	0,080	78
1500	1000	0,085	83
1600	1000	0,091	89
1700	1000	0,096	94
1800	1000	0,102	100

A	B	V	P
1100	1100	0,068	67
1200	1100	0,068	73
1300	1100	0,074	79
1400	1100	0,080	85
1500	1100	0,085	91
1600	1100	0,091	97
1700	1100	0,096	103
1800	1100	0,102	109

Units: mm / V: m³ / P: Kg

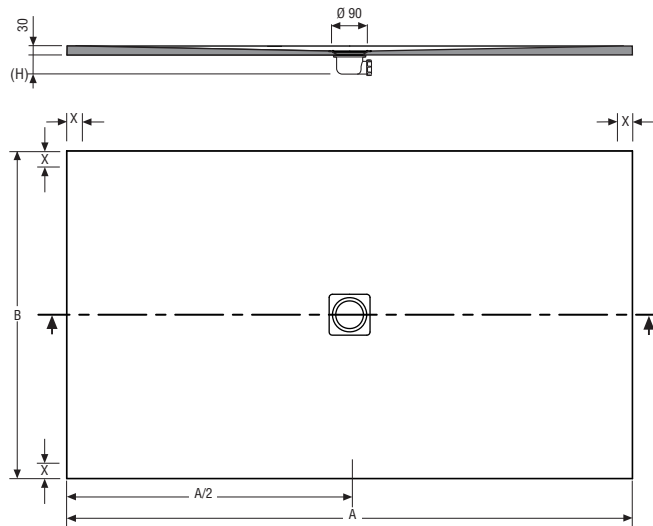
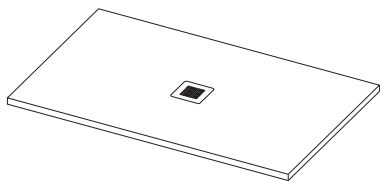

A	B	V	P
1900	700	0,088	75
2000	700	0,098	79

A	B	V	P
1900	750	0,088	80
2000	750	0,098	84

A	B	V	P
1900	800	0,088	85
2000	800	0,098	89

A	B	V	P
1900	900	0,088	94
2000	900	0,098	99

A	B	V	P
1900	1000	0,108	105
2000	1000	0,113	110

A	B	V	P
1900	1100	0,108	115
2000	1100	0,113	121

Units: mm / V: m³ / P: Kg

PLATO DE DUCHA ONE CUADRADO Y ANGULAR / ONE SQUARE AND ANGULAR SHOWER TRAY / RECEVEUR DE DOUCHE ONE CARRÉ ET D'ANGLE / BASE DE CHUVEIRO ONE QUADRADO E ANGULAR

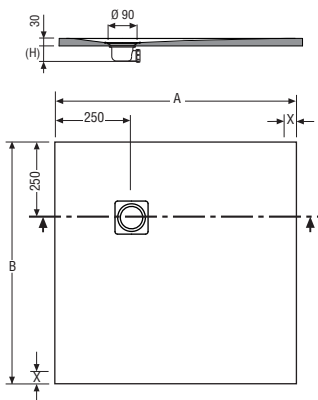

A	B	V	P
800	800	0,047	37
900	900	0,047	46

Units: mm / V: m³ / P: Kg

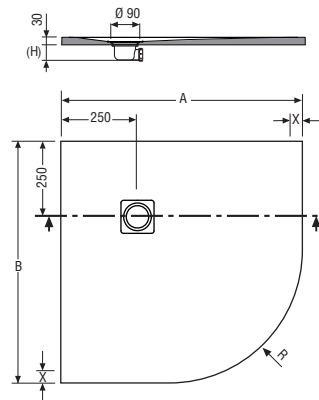

A	B	R	V	P
800	800	550	0,047	34
900	900	550	0,047	42

Units: mm / V: m³ / P: Kg

V Volumen de expedición sin palet (m3) | Shipping volume without palet | Volume à l'expédition sans palet | Volume expedição sin palet

P Peso de expedición sin palet (Kg) | Shipping weight without palet | Poids à l'expédition sans palet | Peso de expedição sin palet

X Zona emplazamiento mampara. El espacio mínimo reservado para la mampara es de 30 mm | Glass enclosure zone. The minimum area reserved for the glass enclosure is 30 mm | Zone d'emplacement de la paroi de douche | L'espace minimum réservé à la paroi est de 30 mm | Zona de colocação da divisória. O espaço mínimo necessário à divisória é de 30 mm

(H) Medida en función del desagüe suministrado | Height according to valve supplied | Mesure en fonction du vidage livré | Medida em funcão da válvula fornecida

| la ducha
| PLATOS DE DUCHA

ARQ





ARQ 110x200 iron, textura cemento



Detalle tapa de desagüe, color graphite, textura cemento





ARQ 90x160 cement, textura cemento



Detalle textura cemento color beige



ALTURA



30 mm

INSTALACIÓN



Sobre pavimento



Encastrado

TAPA Y VÁLVULA



Incluida tapa para desagüe del mismo color, acabado y material que el plato

Incluida válvula Ø50 (UNE EN-274)
Posibilidad de instalar con otras válvulas de Ø50

ACABADO SUPERFICIAL



Acabado textura cemento

Antislip Clase 3 (ENV 12633) | B (DIN 51097) | PN18 (XP P05-011)

MATERIALES Y COLORES

gelcoat

COLOR STANDARD



BIANCO



BEIGE

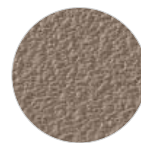

CAPPUCINO

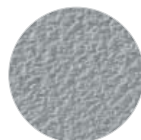

CEMENT

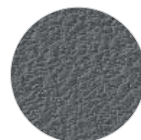

IRON















GRAPHITE



Rectangular



		ARQ					
		gelcoat					
		COLOR BIANCO	COLOR BEIGE	COLOR CAPPUCCINO	COLOR CEMENT	COLOR IRON	COLOR GRAPHITE
		textura cemento	textura cemento	textura cemento	textura cemento	textura cemento	textura cemento
							
70	100-110	SARC 0001	SARC 0061	SARC 0121	SARC 0181	SARC 0241	SARC 0301
	111-120	SARC 0002	SARC 0062	SARC 0122	SARC 0182	SARC 0242	SARC 0302
	121-130	SARC 0003	SARC 0063	SARC 0123	SARC 0183	SARC 0243	SARC 0303
	131-140	SARC 0004	SARC 0064	SARC 0124	SARC 0184	SARC 0244	SARC 0304
	141-150	SARC 0005	SARC 0065	SARC 0125	SARC 0185	SARC 0245	SARC 0305
	151-160	SARC 0006	SARC 0066	SARC 0126	SARC 0186	SARC 0246	SARC 0306
	161-170	SARC 0007	SARC 0067	SARC 0127	SARC 0187	SARC 0247	SARC 0307
	171-180	SARC 0008	SARC 0068	SARC 0128	SARC 0188	SARC 0248	SARC 0308
	181-190	SARC 0009	SARC 0069	SARC 0129	SARC 0189	SARC 0249	SARC 0309
	191-200	SARC 0010	SARC 0070	SARC 0130	SARC 0190	SARC 0250	SARC 0310
71-75	100-110	SARC 0011	SARC 0071	SARC 0131	SARC 0191	SARC 0251	SARC 0311
	111-120	SARC 0012	SARC 0072	SARC 0132	SARC 0192	SARC 0252	SARC 0312
	121-130	SARC 0013	SARC 0073	SARC 0133	SARC 0193	SARC 0253	SARC 0313
	131-140	SARC 0014	SARC 0074	SARC 0134	SARC 0194	SARC 0254	SARC 0314
	141-150	SARC 0015	SARC 0075	SARC 0135	SARC 0195	SARC 0255	SARC 0315
	151-160	SARC 0016	SARC 0076	SARC 0136	SARC 0196	SARC 0256	SARC 0316
	161-170	SARC 0017	SARC 0077	SARC 0137	SARC 0197	SARC 0257	SARC 0317
	171-180	SARC 0018	SARC 0078	SARC 0138	SARC 0198	SARC 0258	SARC 0318
	181-190	SARC 0019	SARC 0079	SARC 0139	SARC 0199	SARC 0259	SARC 0319
	191-200	SARC 0020	SARC 0080	SARC 0140	SARC 0200	SARC 0260	SARC 0320

		ARQ					
		gelcoat					
		COLOR BIANCO	COLOR BEIGE	COLOR CAPPUCCINO	COLOR CEMENT	COLOR IRON	COLOR GRAPHITE
		textura cemento	textura cemento	textura cemento	textura cemento	textura cemento	textura cemento
							
76-80	100-110	SARC 0021	SARC 0081	SARC 0141	SARC 0201	SARC 0261	SARC 0321
	111-120	SARC 0022	SARC 0082	SARC 0142	SARC 0202	SARC 0262	SARC 0322
	121-130	SARC 0023	SARC 0083	SARC 0143	SARC 0203	SARC 0263	SARC 0323
	131-140	SARC 0025	SARC 0084	SARC 0144	SARC 0204	SARC 0264	SARC 0324
	141-150	SARC 0024	SARC 0085	SARC 0145	SARC 0205	SARC 0265	SARC 0325
	151-160	SARC 0026	SARC 0086	SARC 0146	SARC 0206	SARC 0266	SARC 0326
	161-170	SARC 0027	SARC 0087	SARC 0147	SARC 0207	SARC 0267	SARC 0327
	171-180	SARC 0028	SARC 0088	SARC 0148	SARC 0208	SARC 0268	SARC 0328
	181-190	SARC 0029	SARC 0089	SARC 0149	SARC 0209	SARC 0269	SARC 0329
	191-200	SARC 0030	SARC 0090	SARC 0150	SARC 0210	SARC 0270	SARC 0330
81-90	100-110	SARC 0031	SARC 0091	SARC 0151	SARC 0211	SARC 0271	SARC 0331
	111-120	SARC 0032	SARC 0092	SARC 0152	SARC 0212	SARC 0272	SARC 0332
	121-130	SARC 0033	SARC 0093	SARC 0153	SARC 0213	SARC 0273	SARC 0333
	131-140	SARC 0039	SARC 0094	SARC 0154	SARC 0214	SARC 0274	SARC 0334
	141-150	SARC 0035	SARC 0095	SARC 0155	SARC 0215	SARC 0275	SARC 0335
	151-160	SARC 0041	SARC 0096	SARC 0156	SARC 0216	SARC 0276	SARC 0336
	161-170	SARC 0037	SARC 0097	SARC 0157	SARC 0217	SARC 0277	SARC 0337
	171-180	SARC 0038	SARC 0098	SARC 0158	SARC 0218	SARC 0278	SARC 0338
	181-190	SARC 0034	SARC 0099	SARC 0159	SARC 0219	SARC 0279	SARC 0339
	191-200	SARC 0040	SARC 0100	SARC 0160	SARC 0220	SARC 0280	SARC 0340







Rectangular





Rectangular



		ARQ					
		gelcoat					
		COLOR BIANCO	COLOR BEIGE	COLOR CAPPUCCINO	COLOR CEMENT	COLOR IRON	COLOR GRAPHITE
		textura cemento	textura cemento	textura cemento	textura cemento	textura cemento	textura cemento
							
91-100	100-110	SARC 0036	SARC 0101	SARC 0161	SARC 0221	SARC 0281	SARC 0341
	111-120	SARC 0042	SARC 0102	SARC 0162	SARC 0222	SARC 0282	SARC 0342
	121-130	SARC 0043	SARC 0103	SARC 0163	SARC 0223	SARC 0283	SARC 0343
	131-140	SARC 0044	SARC 0104	SARC 0164	SARC 0224	SARC 0284	SARC 0344
	141-150	SARC 0045	SARC 0105	SARC 0165	SARC 0225	SARC 0285	SARC 0345
	151-160	SARC 0046	SARC 0106	SARC 0166	SARC 0226	SARC 0286	SARC 0346
	161-170	SARC 0047	SARC 0107	SARC 0167	SARC 0227	SARC 0287	SARC 0347
	171-180	SARC 0048	SARC 0108	SARC 0168	SARC 0228	SARC 0288	SARC 0348
	181-190	SARC 0049	SARC 0109	SARC 0169	SARC 0229	SARC 0289	SARC 0349
	191-200	SARC 0050	SARC 0110	SARC 0170	SARC 0230	SARC 0290	SARC 0350
101-110	100-110	SARC 0051	SARC 0111	SARC 0171	SARC 0231	SARC 0291	SARC 0351
	111-120	SARC 0052	SARC 0112	SARC 0172	SARC 0232	SARC 0292	SARC 0352
	121-130	SARC 0053	SARC 0113	SARC 0173	SARC 0233	SARC 0293	SARC 0353
	131-140	SARC 0054	SARC 0114	SARC 0174	SARC 0234	SARC 0294	SARC 0354
	141-150	SARC 0055	SARC 0115	SARC 0175	SARC 0235	SARC 0295	SARC 0355
	151-160	SARC 0056	SARC 0116	SARC 0176	SARC 0236	SARC 0296	SARC 0356
	161-170	SARC 0057	SARC 0117	SARC 0177	SARC 0237	SARC 0297	SARC 0357
	171-180	SARC 0058	SARC 0118	SARC 0178	SARC 0238	SARC 0298	SARC 0358
	181-190	SARC 0059	SARC 0119	SARC 0179	SARC 0239	SARC 0299	SARC 0359
	191-200	SARC 0060	SARC 0120	SARC 0180	SARC 0240	SARC 0300	SARC 0360

ARQ código	ancho	x	largo	material	color	textura	forma
				<input type="checkbox"/> Gelcoat	<input type="checkbox"/> blanco <input type="checkbox"/> beige <input type="checkbox"/> cappuccino	<input type="checkbox"/> cement <input type="checkbox"/> iron <input type="checkbox"/> graphite	<input type="checkbox"/> cemento <input type="checkbox"/> rectangular

TAPA VÁLVULA

 **incluido** Tapa para válvula rectangular en mismo acabado que el plato

VÁLVULA

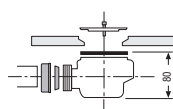

incluido Válvula salida horizontal Viega 50 Domoplex
Según norma EN-274

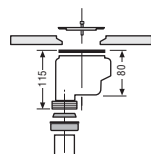

+ Válvula salida vertical Viega 50 Domoplex
Según norma EN-274

CORTE



incluido Cortes longitudinales en ancho y largo cm a cm

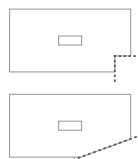

+ Cortes especiales cm a cm
Los pedidos serán confirmados mediante plano técnico



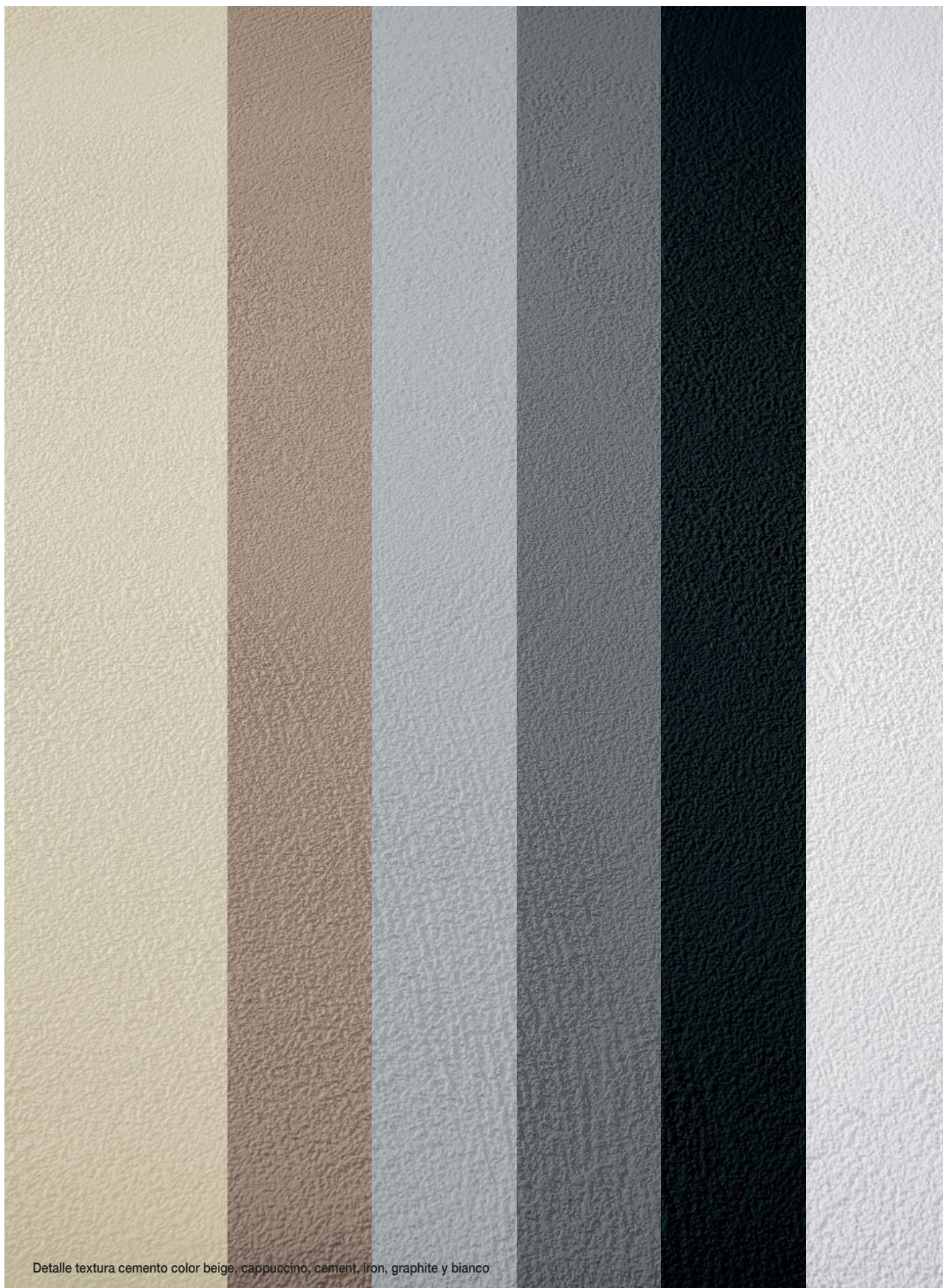

Detalle textura cemento color beige, cappuccino, cement, iron, graphite y blanco

PLATO DE DUCHA ARQ / ARQ SHOWER TRAY / RECEVEUR DE DOUCHE ARQ / BASE DE CHUVEIRO ARQ

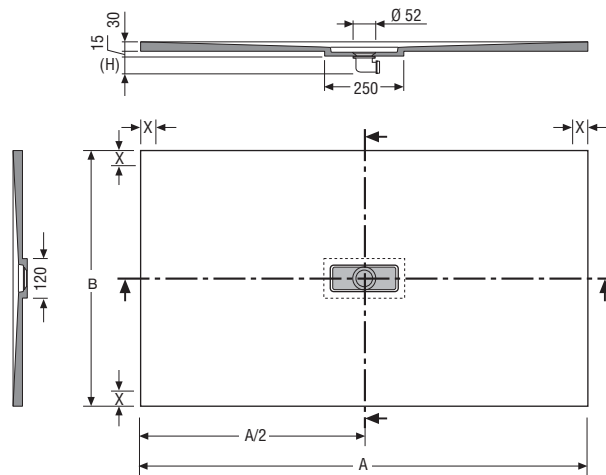
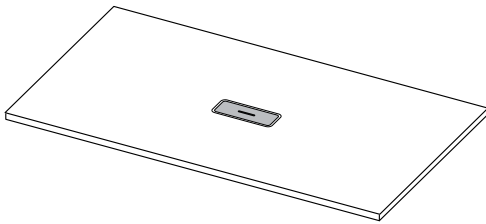

A	B	V	P	A	B	V	P	A	B	V	P
1000	700	0,063	38	1000	750	0,063	40	1000	800	0,063	43
1010 → 1100	700	0,071	42	1010 → 1100	750	0,071	45	1010 → 1100	800	0,071	48
1110 → 1200	700	0,075	46	1110 → 1200	750	0,075	50	1110 → 1200	800	0,075	53
1210 → 1300	700	0,083	50	1210 → 1300	750	0,083	53	1210 → 1300	800	0,083	57
1310 → 1400	700	0,087	54	1310 → 1400	750	0,087	58	1310 → 1400	800	0,087	62
1410 → 1500	700	0,094	57	1410 → 1500	750	0,094	61	1410 → 1500	800	0,094	66
1510 → 1600	700	0,102	62	1510 → 1600	750	0,102	66	1510 → 1600	800	0,102	71
1610 → 1700	700	0,106	65	1610 → 1700	750	0,106	70	1610 → 1700	800	0,106	75
1710 → 1800	700	0,114	69	1710 → 1800	750	0,114	75	1710 → 1800	800	0,114	80
1810 → 1900	700	0,118	72	1810 → 1900	750	0,118	78	1810 → 1900	800	0,118	83
1910 → 2000	700	0,139	78	1910 → 2000	750	0,139	84	1910 → 2000	800	0,139	89

A	B	V	P	A	B	V	P	A	B	V	P
1000	900	0,079	49	1000	1000	0,079	53	1000	1100	0,079	62
1010 → 1100	900	0,089	55	1010 → 1100	1000	0,089	60	1010 → 1100	1100	0,089	69
1110 → 1200	900	0,094	60	1110 → 1200	1000	0,094	66	1110 → 1200	1100	0,094	75
1210 → 1300	900	0,104	65	1210 → 1300	1000	0,104	71	1210 → 1300	1100	0,104	80
1310 → 1400	900	0,109	70	1310 → 1400	1000	0,109	77	1310 → 1400	1100	0,109	86
1410 → 1500	900	0,119	74	1410 → 1500	1000	0,119	81	1410 → 1500	1100	0,119	90
1510 → 1600	900	0,124	80	1510 → 1600	1000	0,124	87	1510 → 1600	1100	0,124	96
1610 → 1700	900	0,134	84	1610 → 1700	1000	0,134	92	1610 → 1700	1100	0,134	101
1710 → 1800	900	0,139	90	1710 → 1800	1000	0,139	98	1710 → 1800	1100	0,139	107
1810 → 1900	900	0,139	94	1810 → 1900	1000	0,139	103	1810 → 1900	1100	0,139	111
1910 → 2000	900	0,139	99	1910 → 2000	1000	0,139	108	1910 → 2000	1100	0,139	118

Medidas en mm / Sizes in mm /
Mesures en mm / Medidas em mm

V Volumen de expedición sin palet (m3) | Shipping volume without palet | Volume à l'expédition sans palet | Volume expedição sin palet
P Peso de expedición sin palet (Kg) | Shipping weight without palet | Poids à l'expédition sans palet | Peso de expedição sin palet
X Zona emplazamiento mampara. El espacio mínimo reservado para la mampara es de 30 mm | Glass enclosure zone. The minimum area reserved for the glass enclosure is 30 mm | Zone d'emplacement de la paroi de douche | L'espace minimum réservé à la paroi est de 30 mm | Zona de colocação da divisória. O espaço mínimo necessário à divisória é de 30 mm
(H) Medida en función del desagüe suministrado | Height according to valve supplied | Mesure en fonction du vidage livré | Medida em função da válvula fornecida

la ducha
PLATOS DE DUCHA

VISUAL



VISUAL 80x120 blanco, acabado textura lisa



VISUAL 90x160 blanco, acabado textura lisa, tapa válvula cromo



ALTURA



INSTALACIÓN



TAPA Y VÁLVULA



Incluida tapa
lisa cromada

Incluida válvula $\varnothing 90$ (UNE EN-274)
Posibilidad de instalar con otras válvulas de $\varnothing 90$

ACABADO SUPERFICIAL



Acabado textura lisa

Tratamiento Antislip Clase 3 (ENV 12633) | C (DIN 51097) | PN24 (XP P05-011), opcional

MATERIALES Y COLORES

acrylic



BLANCO

PLATO DE DUCHA VISUAL RECTANGULAR / VISUAL RECTANGULAR SHOWER TRAY / RECEVEUR DE DOUCHE VISUAL RECTANGULAIRE / BASE DE CHUVEIRO VISUAL RETANGULAR

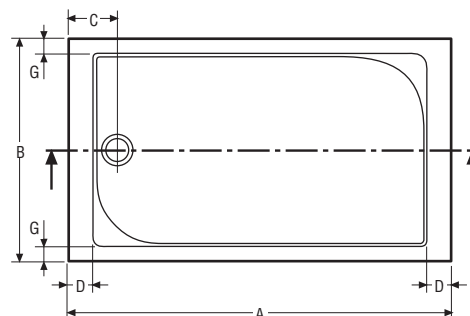
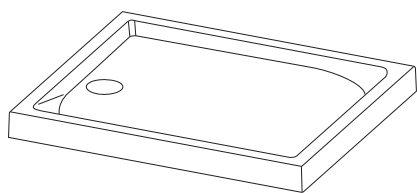

A	1000	1200	1400	1500	1600	1700	900	1000	1200	1400	1600	1800	1100	1400	1600
B	700	700	700	700	700	700	750	800	800	800	800	800	900	900	900
C	153	153	153	153	153	153	123	153	153	153	153	153	165	153	153
D	80	80	80	80	80	80	50	80	80	80	80	80	80	80	80
E	75	75	75	75	75	75	75	75	75	75	75	75	75	75	75
G	50	50	40	50	50	50	50	50	50	50	50	50	50	50	50
Z	35	35	35	35	35	35	35	35	35	35	35	35	35	35	35
V	0,10	0,13	0,15	0,15	0,15	0,19	0,10	0,11	0,13	0,16	0,19	0,19	0,16	0,16	0,19
P	13	14	18	19	20	21	15	14	15	18	20	22	20	20	21

Medidas en mm / Sizes in mm / Mesures en mm / Medidas em mm

PLATO DE DUCHA VISUAL CUADRADO / VISUAL SQUARE SHOWER TRAY / RECEVEUR DE DOUCHE VISUAL CARRÉ / BASE DE CHUVEIRO VISUAL QUADRADO

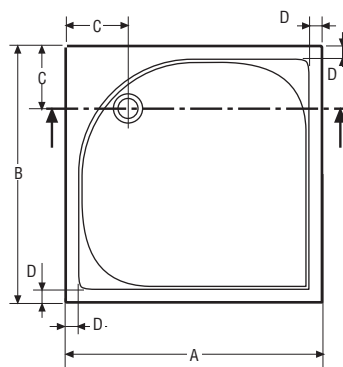
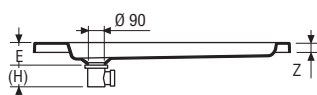
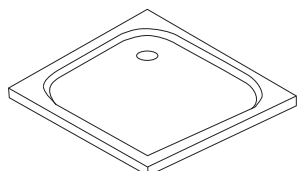

A	800	900
B	800	900
C	161	219
D	50	50
E	75	75
G	50	50
Z	35	35
V	0,10	0,13
P	11	14

Medidas en mm / Sizes in mm / Mesures en mm / Medidas em mm

PLATO DE DUCHA VISUAL ANGULAR / VISUAL ANGULAR SHOWER TRAY / RECEVEUR DE DOUCHE VISUAL D'ANGLE / BASE DE CHUVEIRO VISUAL ANGULAR

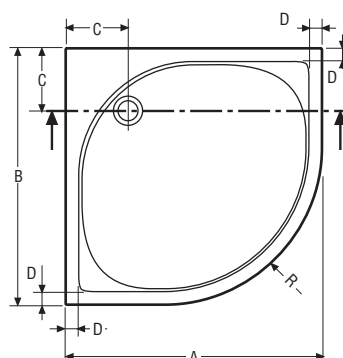
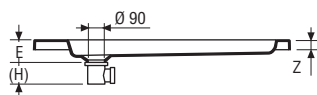
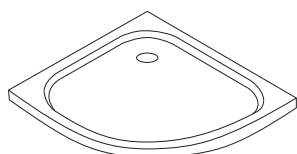

A	750	800	900	1000
B	750	800	900	1000
C	161	161	219	248
D	50	50	50	80
E	75	75	75	75
R	375	550	550	500
Z	35	35	35	35
V	0,10	0,10	0,10	0,13
P	10	10	12	16

Medidas en mm / Sizes in mm / Mesures en mm / Medidas em mm

OPCIONES DEL PRODUCTO E INFORMACIÓN TÉCNICA IMPORTANTE

la ducha
PLATOS DE DUCHA
tarifa

VISUAL

Rectangular		VISUAL Acrylic	
		COLOR BLANCO	
		textura lisa	
70	100	SVIC 0001	
	120	SVIC 0002	
	140	SVIC 0003	
	150	SVIC 0004	
	160	SVIC 0005	
	170	SVIC 0006	
75	90	SVIC 0007	
80	100	SVIC 0008	
	120	SVIC 0009	
	140	SVIC 0010	
	160	SVIC 0011	
	180	SVIC 0012	
90	110	SVIC 0013	
	140	SVIC 0014	
	160	SVIC 0015	

Cuadrado		VISUAL Acrylic	
		COLOR BLANCO	
		textura lisa	
80	80	SVIC 0016	
90	90	SVIC 0017	
Angular			
75	75	SVIC 0018	
80	80	SVIC 0019	
90	90	SVIC 0020	
100	100	SVIC 0021	

VISUAL

x

material

 Acrylic

color

 blanco

textura

 liso

forma

 rectangular
 cuadrado
 angular

TAPA VÁLVULA

incluido Tapa para válvula redonda cromada

VÁLVULA

incluido Válvula salida horizontal D90
Según norma EN-274

+

Válvula salida vertical D90
Según norma EN-274

TRATAMIENTO ANTISLIP

+ Tratamiento Antislip Clase 3 ENV 12633 |
C (DIN 51097) | PN24 (XP P05-011)

la ducha
PANELES

PANELES



PANELES 85x230, blanco, textura pizarra



PANELES

la ducha
PANELES



PANELES 105x240, combinados con Scene® blanco, textura lisa



PANELES combinados con Scene® blanco, textura lisa y perfil TE





PANELES 110x240, combinados con Gelcoat iron, textura cemento



PANELES 80x240, combinados con Marmek® terra, textura pizarra

PANELES

la ducha
PANELES
tarifa

		Paneles para combinar con Scene 10 mm de espesor		Paneles para combinar con marmek y gelcoat 10 mm de espesor					
		COLOR BLANCO		COLOR BIANCO	COLOR STANDARD	COLOR SPECIAL	COLOR BIANCO	COLOR STANDARD	COLOR SPECIAL
		textura lisa	textura pizarra	textura pizarra	textura pizarra	textura pizarra	textura cemento	textura cemento	textura cemento
70-80	80-100	PPAC 0001	PPAC 0032	PPAC 0063	PPAC 0094	PPAC 0125	PPAC 0156	PPAC 0187	PPAC 0218
	101-120	PPAC 0002	PPAC 0033	PPAC 0064	PPAC 0095	PPAC 0126	PPAC 0157	PPAC 0188	PPAC 0219
	121-140	PPAC 0003	PPAC 0034	PPAC 0065	PPAC 0096	PPAC 0127	PPAC 0158	PPAC 0189	PPAC 0220
	141-160	PPAC 0004	PPAC 0035	PPAC 0066	PPAC 0097	PPAC 0128	PPAC 0159	PPAC 0190	PPAC 0221
	161-180	PPAC 0005	PPAC 0036	PPAC 0067	PPAC 0098	PPAC 0129	PPAC 0160	PPAC 0191	PPAC 0222
	181-200	PPAC 0006	PPAC 0037	PPAC 0068	PPAC 0099	PPAC 0130	PPAC 0161	PPAC 0192	PPAC 0223
	201-220	PPAC 0007	PPAC 0038	PPAC 0069	PPAC 0100	PPAC 0131	PPAC 0162	PPAC 0193	PPAC 0224
	221-240	PPAC 0008	PPAC 0039	PPAC 0070	PPAC 0101	PPAC 0132	PPAC 0163	PPAC 0194	PPAC 0225
81-90	81-100	PPAC 0009	PPAC 0040	PPAC 0071	PPAC 0102	PPAC 0133	PPAC 0164	PPAC 0195	PPAC 0226
	101-120	PPAC 0010	PPAC 0041	PPAC 0072	PPAC 0103	PPAC 0134	PPAC 0165	PPAC 0196	PPAC 0227
	121-140	PPAC 0011	PPAC 0042	PPAC 0073	PPAC 0104	PPAC 0135	PPAC 0166	PPAC 0197	PPAC 0228
	141-160	PPAC 0012	PPAC 0043	PPAC 0074	PPAC 0105	PPAC 0136	PPAC 0167	PPAC 0198	PPAC 0229
	161-180	PPAC 0013	PPAC 0044	PPAC 0075	PPAC 0106	PPAC 0137	PPAC 0168	PPAC 0199	PPAC 0230
	181-200	PPAC 0014	PPAC 0045	PPAC 0076	PPAC 0107	PPAC 0138	PPAC 0169	PPAC 0200	PPAC 0231
	201-220	PPAC 0015	PPAC 0046	PPAC 0077	PPAC 0108	PPAC 0139	PPAC 0170	PPAC 0201	PPAC 0232
	221-240	PPAC 0016	PPAC 0047	PPAC 0078	PPAC 0109	PPAC 0140	PPAC 0171	PPAC 0202	PPAC 0233

		Paneles para combinar con Scene 10 mm de espesor		Paneles para combinar con marmek y gelcoat 10 mm de espesor					
		COLOR BLANCO		COLOR BIANCO	COLOR STANDARD	COLOR SPECIAL	COLOR BIANCO	COLOR STANDARD	COLOR SPECIAL
		textura lisa	textura pizarra	textura pizarra	textura pizarra	textura pizarra	textura cemento	textura cemento	textura cemento
91-100	91-100	PPAC 0017	PPAC 0048	PPAC 0079	PPAC 0110	PPAC 0141	PPAC 0172	PPAC 0203	PPAC 0234
	101-120	PPAC 0018	PPAC 0049	PPAC 0080	PPAC 0111	PPAC 0142	PPAC 0173	PPAC 0204	PPAC 0235
	121-140	PPAC 0019	PPAC 0050	PPAC 0081	PPAC 0112	PPAC 0143	PPAC 0174	PPAC 0205	PPAC 0236
	141-160	PPAC 0020	PPAC 0051	PPAC 0082	PPAC 0113	PPAC 0144	PPAC 0175	PPAC 0206	PPAC 0237
	161-180	PPAC 0021	PPAC 0052	PPAC 0083	PPAC 0114	PPAC 0145	PPAC 0176	PPAC 0207	PPAC 0238
	181-200	PPAC 0022	PPAC 0053	PPAC 0084	PPAC 0115	PPAC 0146	PPAC 0177	PPAC 0208	PPAC 0239
	201-220	PPAC 0023	PPAC 0054	PPAC 0085	PPAC 0116	PPAC 0147	PPAC 0178	PPAC 0209	PPAC 0240
	221-240	PPAC 0024	PPAC 0055	PPAC 0086	PPAC 0117	PPAC 0148	PPAC 0179	PPAC 0210	PPAC 0241
101-120	101-120	PPAC 0025	PPAC 0056	PPAC 0087	PPAC 0118	PPAC 0149	PPAC 0180	PPAC 0211	PPAC 0242
	121-140	PPAC 0026	PPAC 0057	PPAC 0088	PPAC 0119	PPAC 0150	PPAC 0181	PPAC 0212	PPAC 0243
	141-160	PPAC 0027	PPAC 0058	PPAC 0089	PPAC 0120	PPAC 0151	PPAC 0182	PPAC 0213	PPAC 0244
	161-180	PPAC 0028	PPAC 0059	PPAC 0090	PPAC 0121	PPAC 0152	PPAC 0183	PPAC 0214	PPAC 0245
	181-200	PPAC 0029	PPAC 0060	PPAC 0091	PPAC 0122	PPAC 0153	PPAC 0184	PPAC 0215	PPAC 0246
	201-220	PPAC 0030	PPAC 0061	PPAC 0092	PPAC 0123	PPAC 0154	PPAC 0185	PPAC 0216	PPAC 0247
	221-240	PPAC 0031	PPAC 0062	PPAC 0093	PPAC 0124	PPAC 0155	PPAC 0186	PPAC 0217	PPAC 0248

PANELES

la ducha
PANELES
información técnica



PERFIL ALUMINIO LISTELO

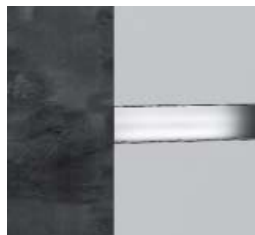

Brillo

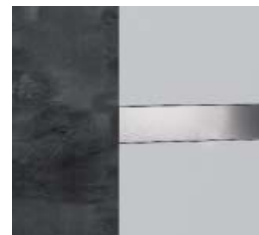

Satinado



PERFIL ALUMINIO REMATE



Brillo



Satinado



PERFIL ALUMINIO TE



Brillo



Satinado

PANEL código	ancho x alto	combinado con <input type="checkbox"/> Scene <input type="checkbox"/> Marmek o Gelcoat	color <input type="checkbox"/> blanco <input type="checkbox"/> blanco <input type="checkbox"/> standad <input type="checkbox"/> special	textura <input type="checkbox"/> liso <input type="checkbox"/> pizarra <input type="checkbox"/> cemento	forma <input type="checkbox"/> rectangular
-----------------	--------------	--	---	--	---

CORTE

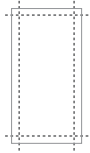

incluido Cortes longitudinales en ancho y largo cm a cm



+ Cortes especiales cm a cm

Los pedidos serán confirmados mediante plano técnico



OTROS COMPLEMENTOS: PERFILES

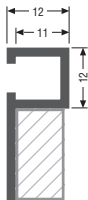

* Perfil aluminio listelo 10 mm Brillo
PPRS 0001 Longitud 2,6 m

* Perfil aluminio listelo 10 mm Satinado
PPRS 0002 Longitud 2,6 m



* Perfil aluminio remate 10 mm Brillo
PPRS 0003 Longitud 2,6 m

* Perfil aluminio remate 10 mm Satinado
PPRS 0004 Longitud 2,6 m

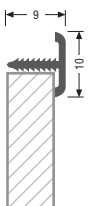

* Perfil aluminio TE 10 mm Brillo
PPRS 0005 Longitud 2,5 m

* Perfil aluminio TE 10 mm Satinado
PPRS 0006 Longitud 2,5 m

tarifa

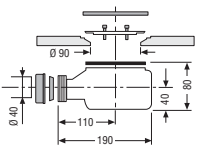
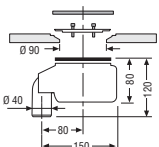
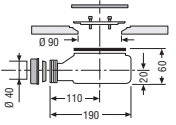
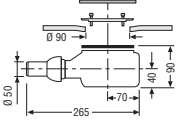
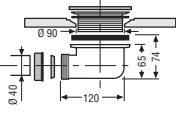
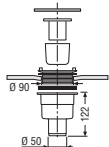
VÁLVULAS PARA SERIES			
UNIQUE (en borde o interior) SELECT STUDIO PLUS ZONE CUBE & QUADRO NATURE & NEO ONE	VSPS 0001	Válvula salida horizontal Viega 90 Tempoplex. Según norma EN-274. Caudal de evacuación: 0,64 l/s a 15 mm c/a	
	VSPS 0002	Válvula salida vertical Viega 90 Tempoplex. Según norma EN-274. Caudal de evacuación: 0,64 l/s a 15 mm c/a	
	VSPS 0003	Válvula salida horizontal Viega 90 Tempoplex Extraplana. Caudal de evacuación: 0,55 l/s a 15 mm c/a	
	VSPS 0004	Válvula salida horizontal Viega 90 Tempoplex Plus. Caudal de evacuación: 0,85 l/s a 15 mm c/a	
	VSPS 0005 (Antiguo código 410001494)	Válvula salida horizontal. Según norma EN-274. Caudal de evacuación: 0,42 l/s a 15 mm c/a	
	VSPS 0006 (Antiguo código 410001733)	Válvula salida vertical. Según norma EN-274. Caudal de evacuación: 0,42 l/s a 15 mm c/a	

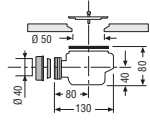
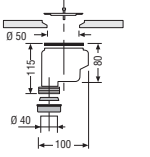
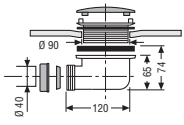
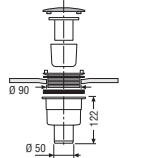
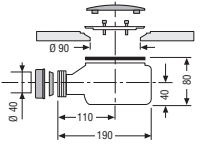
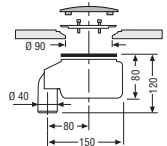
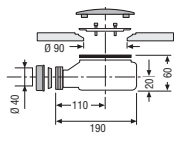
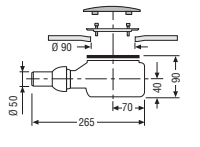
VÁLVULAS PARA SERIES			
LINE & MOON ARQ	VSPS 0007	Válvula salida horizontal Viega 50 Domoplex. Según norma EN-274. Caudal de evacuación: 0,4 l/s a 15 mm c/a	
	VSPS 0008	Válvula salida vertical Viega 50 Domoplex. Según norma EN-274. Caudal de evacuación: 0,4 l/s a 15 mm c/a	
VISUAL	VSPS 0009	Válvula salida horizontal D90. Según norma EN-274. Caudal de evacuación: 0,42 l/s a 15 mm c/a	
	VSPS 0010	Válvula salida vertical D90. Según norma EN-274. Caudal de evacuación: 0,42 l/s a 15 mm c/a	
	VSPS 0011	Válvula salida horizontal Viega 90 Tempoplex. Según norma EN-274. Caudal de evacuación: 0,64 l/s a 15 mm c/a	
	VSPS 0012	Válvula salida vertical Viega 90 Tempoplex. Según norma EN-274. Caudal de evacuación: 0,64 l/s a 15 mm c/a	
	VSPS 0013	Válvula salida horizontal Viega 90 Tempoplex Extraplana. Caudal de evacuación: 0,55 l/s a 15 mm c/a	
	VSPS 0014	Válvula salida horizontal Viega 90 Tempoplex Plus. Caudal de evacuación: 0,85 l/s a 15 mm c/a	

* Los accesorios o complementos de producto que no sean solicitados con el producto principal serán tratados como repuestos o complementos, según su tarifa y con recargo por transporte. Para otras opciones asesórese contactando con el servicio de Atención al Cliente.

tarifa

KITS PARA SERIES	
UNIQUE SELECT STUDIO PLUS ZONE LINE CUBE NATURE	KSPC 0001 Kit reparación Scene (Blanco, Crema o Gris)
	KSPS 0001 Kit restauración Scene Graphite
UNIQUE SELECT MOON QUADRO NEO	KSPS 0002 Kit reparación Marmek (para aporte de material en la base)
	KSPC 0002 Kit retoque Marmek colores Standard o Special (para restauraciones pequeñas en superficie)
	KSPC 0003 Kit restauración Marmek colores Standard o Special (para restauraciones medias y grandes en superficie)
ONE ARQ	KSPS 0003 Kit reparación Gelcoat (para aporte de material en la base)
	KSPC 0004 Kit retoque Gelcoat colores Standard (para restauraciones pequeñas en superficie)
	KSPC 0005 Kit restauración Gelcoat colores Standard (para restauraciones medias y grandes en superficie)

TAPAS VÁLVULAS PARA SERIES			
UNIQUE (en borde o interior)	VSPTS 0015	Tapa rectangular para desaguado en borde de Scene, textura lisa, color blanco	
	VSPC 0001	Tapa rectangular para desaguado en borde de Marmek, textura lisa, color Standard o Special	
	VSPS 0016	Tapa rectangular para desaguado en interior de Scene, textura lisa, color blanco	
	VSPC 0002	Tapa rectangular para desaguado en interior de Marmek, textura lisa, color Standard o Special	
UNIQUE (en interior) SELECT CUBE & QUADRO NATURE & NEO	VSPS 0017	Rejilla redonda inox	
	VSPC 0003	Rejilla redonda color Standard o Special	
	VSPS 0018	Rejilla cuadrada inox	
	VSPC 0004	Rejilla cuadrada color Standard o Special	
STUDIO PLUS	VSPS 0019	Tapa rectangular de Scene, textura lisa, color blanco	
ZONE	VSPS 0020	Tapa cuadrada de Scene, textura lisa, color blanco	
LINE & MOON	VSPS 0021	Tapa L60 inox Para Line/Moon X con anchos de 70 a 80	
	VSPS 0022	Tapa L70 inox Para Line/Moon X con anchos de 71 a 90 y Line/Moon Y	
	VSPS 0023	Tapa L80 inox Para Line/Moon X con anchos de 91 a 100	
LINE	VSPS 0024	Tapa L60 de Scene, textura lisa, color blanco Para Line X con anchos de 70 a 80	
	VSPS 0025	Tapa L70 de Scene, textura lisa, color blanco Para Line X con anchos de 71 a 90 y Line Y	
	VSPS 0026	Tapa L80 de Scene, textura lisa, color blanco Para Line X con anchos de 91 a 100	
	VSPS 0027	Tapa L60 de Scene, textura pizarra, color blanco Para Line X con anchos de 70 a 80	
	VSPS 0028	Tapa L70 de Scene, textura pizarra, color blanco Para Line X con anchos de 71 a 90 y Line Y	
	VSPS 0029	Tapa L80 de Scene, textura pizarra, color blanco Para Line X con anchos de 91 a 100	
MOON	VSPC 0005	Tapa L60 de Marmek, textura lisa, color Standard o Special Para Moon X con anchos de 70 a 80	
	VSPC 0006	Tapa L70 de Marmek, textura lisa, color Standard o Special Para Moon X con anchos de 71 a 90 y Moon Y	
	VSPC 0007	Tapa L80 de Marmek, textura lisa, color Standard o Special Para Moon X con anchos de 91 a 100	
	VSPC 0008	Tapa L60 de Marmek, textura pizarra, color Standard o Special Para Moon X con anchos de 70 a 80	
	VSPC 0009	Tapa L70 de Marmek, textura pizarra, color Standard o Special Para Moon X con anchos de 71 a 90 y Moon Y	
	VSPC 0010	Tapa L80 de Marmek, textura pizarra, color Standard o Special Para Moon X con anchos de 91 a 100	
ONE	VSPS 0030	Rejilla cuadrada inox	
	VSPC 0011	Rejilla cuadrada color Standard	
ARQ	VSPC 0012	Tapa rectangular Gelcoat, textura cemento, color Standard	
VISUAL	VSPS 0031	Tapa redonda cromada	

Scene

Es una composición avanzada de materias minerales, polímeros orgánicos y aditivos específicos cuya finalidad es la consecución de formas complejas por molde. Lo podemos situar entre los materiales denominados "solid surface", es decir un material sintético homogéneo que no tiene piel, por lo que la superficie expuesta tiene las mismas propiedades que el interior. Está formulado y producido para la consecución de productos finales destinados a la arquitectura. Especialmente interesante es su aplicación en el ámbito del baño debido a sus excelentes características físicas, mecánicas, químicas e higiénicas. Estas propiedades, junto con la belleza resultante de las piezas por su aspecto y diseño, lo hacen resaltar en su comparación con otros materiales.



Gran rigidez



Agradable al tacto



Antideslizante



Antibacteriano

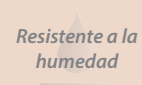

*Resistente a la
humedad*

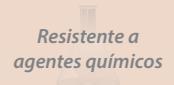

*Resistente a
agentes químicos*

Colores y texturas

TEXTURA LISA



BLANCO

TEXTURA PIZARRA



BLANCO



BLANCO
TEXTURA LISA

marmek

Es un compuesto compacto realizado con resinas y cargas minerales derivadas del mármol que le otorga una elevada dureza y excelentes características al material para su uso en el baño. El acabado superficial puede personalizarse en infinitas posibilidades y presenta una excelente resistencia a la limpieza y a productos de higiene habituales. El material tiene altas prestaciones antibacterianas y es especialmente adecuado para la realización de platos de ducha por su comportamiento antislip.

Colores y texturas

STANDARD COLOURS



SPECIAL COLOURS



RAL / NCS

Los colores se suministran en gama mate. No se aceptan pedidos de colores brillo o efectos metálicos puesto que se alterarían las características en el producto. Ante cualquier duda, infórmese en nuestro servicio de atención al cliente.

TEXTURA LISA
TEXTURA PIZARRA



gelcoat

Es un compuesto compacto realizado con resinas y cargas minerales variadas, que cuenta con una capa exterior de Gel Coat ISO NPG de máxima calidad y que otorga una elevada dureza y excelentes características al material para su uso en el baño. El acabado superficial puede presentarse en diferentes colores y texturas y presenta una excelente resistencia a productos de higiene habituales y facilidad de limpieza para garantizar su durabilidad.

Colores y texturas

STANDARD COLOURS

BIANCO



BEIGE



CAPPUCCINO



GRAPHITE



IRON



CEMENT



TEXTURA PIZARRA



TEXTURA CEMENTO

TEXTURA PIZARRA



TEXTURA CEMENTO



CONDICIONES GENERALES DE VENTA

ÁMBITOS DE APLICACIÓN

Estas Condiciones Generales de Venta son aplicables a todas las ventas y/o servicios descritos, mencionados, promocionados o incluidos en cualquiera de sus formas, en nuestros catálogos, promociones, listas de precios, y presupuestos. Absara Industrial S.L. se reserva el derecho a modificar los presentes términos y condiciones de venta.

PEDIDOS

La realización de un pedido supone la aceptación incondicional de las presentes Condiciones Generales de Venta. La notificación de pedidos por parte del cliente, se realizará por escrito, vía correo electrónico (comercial@absaraindustrial.com) o fax (964 691 922), y sólo serán vinculantes una vez aceptados por Absara Industrial S.L. mediante la emisión de una confirmación de pedido por medio de correo electrónico. El cliente de Absara Industrial S.L. deberá revisar la confirmación de pedido y, en su caso, notificar por escrito y de inmediato cualquier discrepancia. Los presupuestos y/u ofertas económicas realizadas por Absara Industrial S.L. sólo serán válidos por escrito y durante el plazo que en ellos se indique. De no indicarse ningún plazo éste será de 30 días naturales. La venta de cualquier producto incluido en esta tarifa se efectuará siempre en firme y condicionada a la obtención de coberturas de riesgo por parte de la compañía aseguradora de crédito de Absara Industrial S.L., consecuentemente en ningún caso se entenderá que el cliente de Absara Industrial S.L. recibe la mercancía en concepto de depósito o cualquier tipo de institución distinta de la mera compraventa mercantil.

ENTREGA / ACEPTACIÓN / DEVOLUCIÓN

Los plazos de entrega se considerarán siempre orientativos, no aceptando ningún tipo de responsabilidad en el caso de demoras que no excedan de 15 días de la fecha originariamente convenida y en ningún caso en aquellas originadas por causas de fuerza mayor. El comprador de Absara Industrial S.L. asume la obligación de examen inmediato de la mercancía recibida y en el caso de presentar ésta cualquier incidencia relativa a cantidad o calidad de las mismas, ésta deberá ser tramitada durante las veinticuatro horas posteriores a su entrega. Una vez transcurrido este plazo, el producto se considerará aceptado por parte del cliente y no cabrá reclamación alguna por este concepto. Absara Industrial S.L. no admitirá ningún tipo de devolución sin su previa autorización por escrito que será expresa y para cada caso concreto y siempre contemplará el resarcimiento de los gastos causados así como una reducción del importe del precio de la mercancía.

PRECIOS Y TÉRMINOS DE PAGO

Los precios de esta tarifa son precios venta público orientativos y no incluyen I.V.A. ni otros impuestos o cualquier recargo a que pudiera ser sometida la venta por organismos oficiales. Absara Industrial, S.L. retendrá el dominio de la mercancía servida, incluso en el supuesto de que hubiera sido transmitida a terceros hasta que sus importes le hayan sido totalmente liquidados. Cualquier demora en el cumplimiento de las obligaciones de pago del precio de las mercancías o servicios suministrados provocará la retención inmediata de todos los pedidos en curso.

GARANTÍA

Las Garantías se rigen por la legislación vigente al respecto y por las garantías comerciales que extendiendo las legales se incluyen en la póliza de garantía que se entrega junto al producto.

INSTALACIÓN Y MONTAJE DE PRODUCTOS

Los productos exigen que su instalación y montaje sea realizado por personal cualificado y siguiendo siempre las instrucciones del producto y que se acompañen en cada uno de los artículos. El personal que proceda a la instalación del producto, especialmente en platos de ducha, deberá verificar el producto previamente a su instalación, llevar a cabo la instalación de manera correcta, verificándolo a su fin antes de terminar la obra con alicatados, instalación de mamparas, etc. Absara Industrial S.L. o en su caso la empresa vendedora no se hará cargo de los costes que puedan ocasionarse derivados de no respetar este proceso, tales como desmontaje de mampara, reposición de azulejos o pavimentos, etc.

PROTECCIÓN DE DATOS

El cliente que suscribe el contrato reconoce frente a Absara Industrial S.L., de conformidad con lo regulado en la Ley Orgánica 15/1999 de 13 de diciembre sobre tratamiento automatizado de los datos de carácter personal, que presta su consentimiento expreso para que los datos indicados puedan ser tratados automatizadamente con el fin de entablar la relación comercial oportuna. Asimismo, podrá hacerse uso de esta información para ofrecer al cliente productos o servicios de la empresa.

Conforme a la Ley de Protección de Datos, el cliente de Absara Industrial S.L. podrá ejercer en cualquier momento el derecho a acceder, rectificar y cancelar sus datos y oponerse a su tratamiento, dirigiéndose por correo electrónico a Absara Industrial S.L. en su dirección comercial@absaraindustrial.com.

PARTICULARIDADES DE VENTA

Los precios de venta al público incluidos en la presente tarifa podrán verse modificados en las condiciones particulares que con carácter general o puntual establezca Absara Industrial, S.L. con cada uno de sus clientes, en el bien entendido que tal modificación deberá constar por escrito con la aceptación de ambas partes. Esta tarifa anula todas las anteriores y es propiedad de Absara Industrial, S.L. al igual que toda la documentación suministrada, reservándose el derecho a introducir cualquier modificación en la misma y no haciéndose responsable de cualquier error contenido en ella.

hidrobox[®]

by absara

ES

 +34 964 105 176

 comercial@absaraindustrial.com

EN

 +34 964 657 272

 export@absaraindustrial.com

FR

  N°Azur 0 811 66 57 41

PRIX APPEL LOCAL

 france@absaraindustrial.com

DE

 Rufen Sie uns an unter unsere Kunden Hotline:
+49 01 807 808 777

Erste 30 Sekunden kostenlos; Vom Festnetz 0.14 cent/Minute; Vom Mobilnetz 0.42 cent/Minute

 deutschland@absaraindustrial.com

ABSARA INDUSTRIAL S.L.
Partida Saloni, s/n • 12130 San Juan de Moró • Castellón SPAIN
Tel. +34 964 657 272 • Fax +34 964 691 922
absara@absaraindustrial.com • www.hidrobox.com